

HFT Fasteners AG

Bösch 37, CH-6331 Hünenberg
Telefon +41-41 780 70 01 Fax +41-41 780 73 49
Email: info@hft-fasteners.ch
Internet: www.hft-fasteners.ch



ISO 9001 Nr. 96-241-041

Blindniete, Nietmuttern und bewährte Nietgeräte für Industrie, Apparatebau, Heizungs- und Lüftungsbau

**2
FAR & ANZI**

Rivets aveugles, inserts filetés et riveteuses éprouvées pour industrie, appareillage, chauffage et ventilation

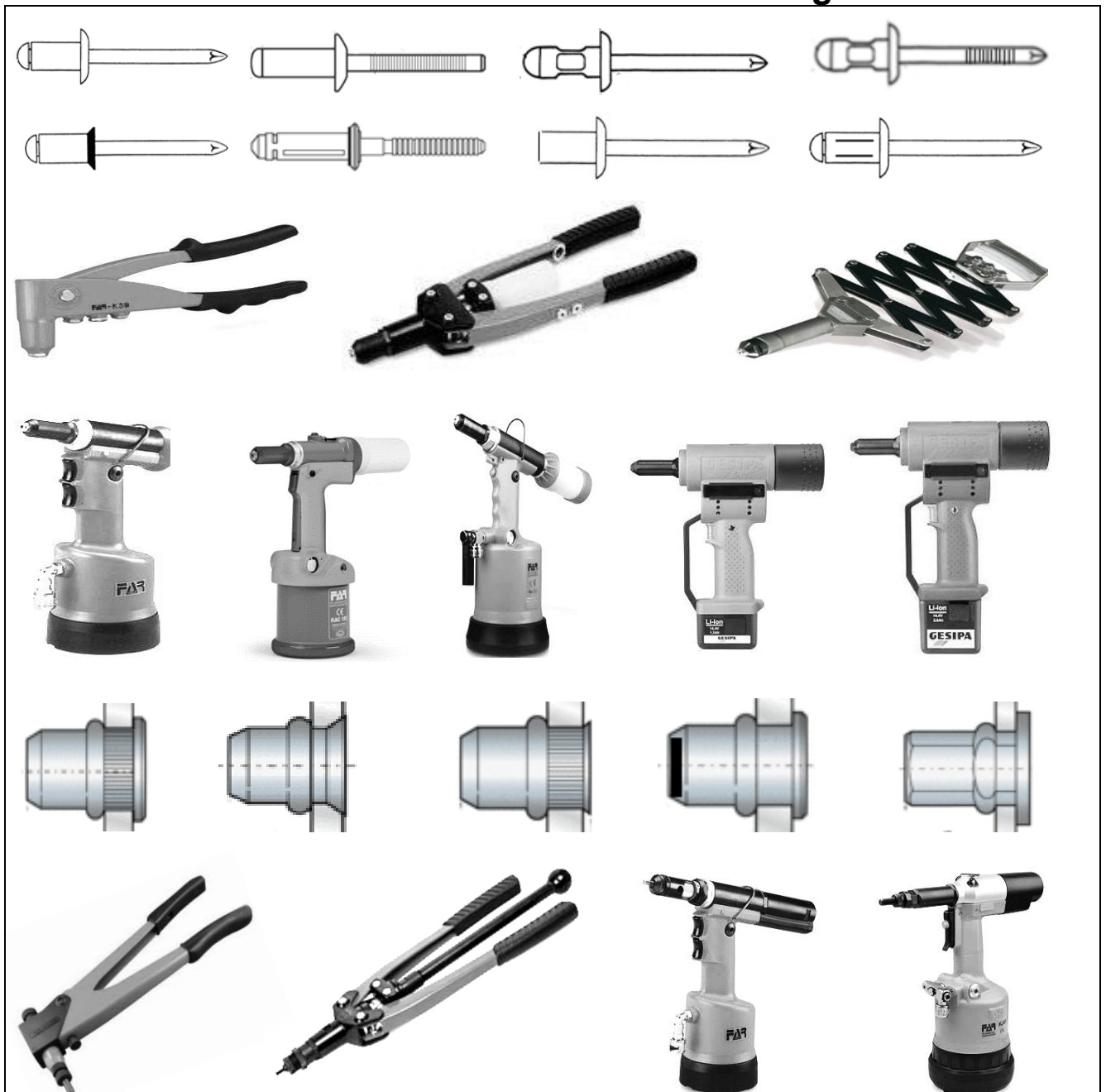

Wir beraten und unterstützen Sie während der Projektierungsphase und vor Ort

Nous vous conseillons et aidons lors de l'étude du projet et sur place

01/2024

HFT Fasteners AG

Bösch 37, CH-6331 Hünenberg

Telefon +41-41 780 70 01 Fax +41-41 780 73 49

Email: info@hft-fasteners.ch

Internet: www.hft-fasteners.ch

ISO 9001 Nr. 96-241-041



HFT Fasteners AG

Bösch 37, CH-6331 Hünenberg
Telefon +41-41 780 70 01 Fax +41-41 780 73 49
Email: info@hft-fasteners.ch
Internet: www.hft-fasteners.ch

ISO 9001 Nr. 96-241-041



Die HFT-Philosophie

Den HFT-Mitarbeitern macht es Spass, ihren Kunden in Sachen Befestiger für

- **Metалldächer- und Metall-Fassaden**
- **den Industrie- und Apparatebau**
- **den Metall- und Fahrzeugbau sowie**
- **Bau- und Lüftungsisolationen**

beratend zur Seite zu stehen.

Die benötigten Befestiger und Werkzeuge sollen termingerecht und preiswert beschafft werden.

*Die HFT legt Wert darauf, dass sich ihre Kunden **vor, während und nach** dem Kauf bestens betreut fühlen, und sich auf die nächste Zusammenarbeit mit der HFT freuen.*

La philosophie de HFT

Les collaborateurs de HFT ont plaisir de conseiller leurs clients en matière de fixations pour

- **toitures et façades métalliques**
- **l'industrie et l'appareillage**
- **constructions métalliques et de voiture**
- **les isolations pour bâtiments et pour climatisations**

et de les conseiller.

Il est crucial que les fixations et outils nécessaires arrivent à temps et à bon prix.

*HFT insiste que leurs clients se sentent à l'aise **avant, pendant et après** leur achat pour qu'ils se réjouissent à la prochaine collaboration avec HFT.*

HFT Fasteners AG

Bösch 37, CH-6331 Hünenberg
 Telefon +41-41 780 70 01 Fax +41-41 780 73 49
 Email: info@hft-fasteners.ch
 Internet: www.hft-fasteners.ch



ISO 9001 Nr. 96-241-041

Inhalt

Table de matière

Blindnieten (Bruttopreise)		Seite / page	Rivets aveugles (prix bruts)	
Alu / Stahl	Blindniet Flachrundkopf	7/8	alu / acier	Rivet aveugle tête plate
Alu / Stahl (Anzi)	Blindniet Flachrundkopf	9	alu / acier (Anzi)	Rivet aveugle tête plate
Alu / Inox	Blindniet Flachrundkopf	10	alu / inox	Rivet aveugle tête plate
Alu / Alu	Blindniet Flachrundkopf	11	alu / alu	Rivet aveugle tête plate
Stahl / Stahl	Blindniet Flachrundkopf	12	acier / acier	Rivet aveugle tête plate
Inox / Inox	Blindniet Flachrundkopf	13	inox / inox	Rivet aveugle tête plate
Inox / Inox (Anzi)	Blindniet Flachrundkopf	14	inox / inox (Anzi)	Rivet aveugle tête plate
Inox / Inox	Blindniete Grosskopf Ø 14mm	15	inox / inox	Rivet avec grande tête ø14mm
Alu / Stahl	Blindniet Senkkopf	16	alu / acier	Rivet aveugle tête fraisée
Alu / Inox	Blindniet Senkkopf	17	alu / inox	Rivet aveugle tête fraisée
Inox / Inox	Blindniet Senkkopf	18	inox / inox	Rivet aveugle tête fraisée
Alu/Stahl	Multi Senkkopf grosser Klemmb	19	alu/acier	Multi tête fraisée
Alu / Stahl	Multi und Grosskopf Ø 16mm	20	alu / acier	Multi avec grande tête ø16mm
Alu / Inox	Multi und Grosskopf Ø 16mm	21	alu / inox	Multi avec grande tête ø16mm
Inox / Inox	Multi mit gerilltem Dorn	22	inox / inox	Rivet Multi avec mandrin reillé
Inox / Inox	Multi PLUS Niet	23	inox / inox	Rivet Multi PLUS
Stahl / Stahl	Multi Tamp gerillter Dorn	24	acier / acier	Rivet Multi Tamp mandrin reillé
Alu / Stahl	Becher-Dichtniet + Senkkopf	25	alu / acier	Rivet étanche + tête fraisée
Alu / Inox	Becher-Dichtniet	26	acier / inox	Rivet étanche
Stahl/Stahl	Becher-Dichtniet	26	acier / acier	Rivet étanche
Inox / Inox	Becher-Dichtniet	27	inox / inox	Rivet étanche
CrNi/Inox – CB	Spenglerniet CB / CRNI	28	CrNi / inox – CB	Rivet ferblantier CrNi et Cb
Alu / Stahl	Sternniet	29	alu / acier	Rivet étoile
Inox / Inox	Sternniet	29	inox / inox	Rivet étoile
Alu / Alu & St / St	Bulb Tite	30	alu / alu & ac. / ac.	Rivet Bulb Tite
Alu / Inox	Fassaden-Blindniet (Alucobond)	31	alu / inox	Rivet de façade (Alucobond)
Alu / Inox	Hammerschlagniet	31	alu / inox	Rivet à marteau
Alu / Stahl	Gerillter Niet	32	alu / acier	Rivet cannelé
Blindnietmuttern (Bruttopreise)			Inserts filetés (prix bruts)	
Flachkopf m.Rand	Alu FTT	34	tête cylindrique	alu FTT
Flachkopf m.Rand	Stahl FTT	35	tête cylindrique	acier FTT
Flachkopf m.Rand	Inox FTT	36	tête cylindrique	inox FTT
Senkkopf	Alu FTS	37	tête fraisée	alu FTS
Senkkopf	Stahl FTS	38	tête fraisée	acier FTS
Senkkopf	Inox FTS	39	tête fraisée	inox FTS
Kleinkopf gerändelt	Stahl FTR	40	tête réduite cannelé	acier FTR
Kleinkopf gerändelt	Inox FTR	41	tête réduite cannelé	inox FTR
Geschlossene	Alu FTTC	42	fermé	alu FTTC
Geschlossene	Stahl FTTC	43	fermé	acier FTTC
Flachkopf gerändelt	Stahl FTT-Z	44	cannelé cylindrique	acier FTT-Z
6-kt. Flachk.geschl.	Stahl FTTEC	45	hexagonal fermé	acier FTTEC
Teil-6-kt. Kleinkopf	Stahl FTRE	45	en partie hexagonal, tête réduite	acier FTRE
Teil-6-kt. Kleinkopf	Inox IE-Inox	46	en partie hexagonal, tête réduite	inox IE-Inox
Teil-6-kt. Kleinkopf	Stahl IE-Stahl	46	en partie hexagonal, tête réduite	acier IE-acier
Geräte und Bohrer (Nettopreise)			Outils et mèches (prix nets)	
Nasslackieren Nieten		47	Thermolaque rivets	
Hand-Nietwerkzeuge		48	Outils à rivet à main	
Pneumatische Nietpistolen		49	Riveteuses pneumatiques	
Akku-Nieter		50 - 51	Riveteuses à accu	
Nietmuttern-Geräte		52	Outils pour inserts filetés	
Nietenbohrer HSS DIN 1897		53	Mèches pour rivets HSS DIN 1897	

HFT Fasteners AG

Bösch 37, CH-6331 Hünenberg
Telefon +41-41 780 70 01 Fax +41-41 780 73 49
Email: info@hft-fasteners.ch
Internet: www.hft-fasteners.ch

ISO 9001 Nr. 96-241-041



Verkaufskonditionen

Praktisch das gesamte Lieferprogramm ist kurzfristig ab HFT lieferbar.

Aufträge die bis 16 Uhr eintreffen gehen noch am gleichen Tag weg.

Preise ohne MWSt
Änderungen vorbehalten
inkl. Verpackung

Rabatt Auf **Brutto-Preise** nach Vereinbarung: _____

Lieferung Frachtkostenanteil pro Lieferung:

pro Paket bis 30 kg: Fr. 10.-
pro Palett per Camion: Fr. 60.-
Postexpress: zu Selbstkosten
Rückstand-Lieferungen: franko

Zahlung nach Vereinbarung

Warenrücknahme

Bitte haben Sie Verständnis für folgende Regelung:

Wir nehmen gelieferte Ware grundsätzlich nur im gegenseitigen Einverständnis zurück, bei franko Rücksendung und mit Abzug von 20% des fakturierten Betrages auf der Gutschrift.

Bitte haben Sie ferner Verständnis für folgendes:

Bei Aufträgen unter Fr. 100.- brutto entfällt der Rabatt auf die Bruttopreise.

Diese Verkaufskonditionen gelten bis auf Widerruf.

Conditions de vente

Pratiquement le programme complet est livrable de HFT à court terme.

Les commandes qui nous parviennent jusqu'à 16 heures partent le même jour.

Prix sans TVA
sous réserve de changer emballage y compris

Rabais sur les **prix bruts**
à convenir : _____

Livraison participation aux frais de transport par livraison :

par paquet max. 30 kg : Fr. 10.-
par palette par camion : Fr. 60.-
poste express aux frais effectifs
livraisons de solde: franco

Payment à convenir

Reprise de marchandise

Ayez-compréhension pour la réglementation suivante, s.v.p.:

Nous reprenons de la marchandise livrée uniquement avec notre accord, nous livrée franco et en déduisant 20% du montant facturé sur la note de crédit.

En outre soyez informé que:

les commandes en dessous de Fr. 100.- bruts ne bénéficient pas de rabais.

Ces conditions sont valables jusqu'à nouvel ordre.

HFT Fasteners AG

Bösch 37, CH-6331 Hünenberg
Telefon +41-41 780 70 01 Fax +41-41 780 73 49
Email: info@hft-fasteners.ch
Internet: www.hft-fasteners.ch

ISO 9001 Nr. 96-241-041



*Die Preise bis Seite 47 sind **brutto minus dem vereinbarten Rabatt** + MWST.*

*Les prix jusqu'à la page 47 sont **bruts moins le rabais convenu** + TVA.*

HFT Fasteners AG

Bösch 37, CH-6331 Hünenberg
Telefon +41-41 780 70 01 Fax +41-41 780 73 49
Email: info@hft-fasteners.ch
Internet: www.hft-fasteners.ch

ISO 9001 Nr. 96-241-041





Blindniet Flachrundkopf

Alu / Stahl

alu / acier
Typ FAR N02

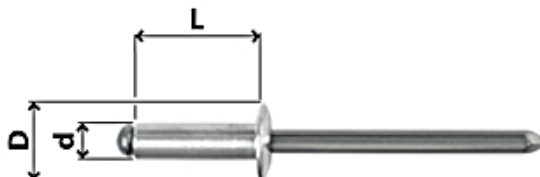
Rivet aveugle tête plate



d Ø (mm)		L	D	K	mm	Art.	Fr./100	Verp. unité
3,2 ↔ 1250 ✂ 900 max (N)	3,3	6	6,5	0,8	0,5 - 3,0	N0232060	2.40	1000
		8			3,0 - 5,0	N0232080	2.60	1000
		10			5,0 - 7,0	N0232100	3.10	1000
		12			7,0 - 9,0	N0232120	3.10	500
		14			9,0 - 11,0	N0232140	3.40	500
		16			11,0 - 13,0	N0232160	4.-	500

4,0 ↔ 2000 ✂ 1400 max (N)	4,1	6	8	1,0	1,5 - 2,5	N0240060	2.50	1000
		8			2,5 - 4,5	N0240080	2.90	1000
		10			4,5 - 6,5	N0240100	3.-	500
		12			6,5 - 8,5	N0240120	3.60	500
		14			8,5 - 10,5	N0240140	4.-	500
		16			10,5 - 12,5	N0240160	4.20	500
		18			12,5 - 14,5	N0240180	4.40	500
		20			14,5 - 16,5	N0240200	4.70	500
		25			16,5 - 21,5	N0240250	5.60	500

Bestellbeispiel:
Blindniet Alu / Stahl
3,2 x 6 oder
Art. N0232060

Exemple de commande:
Rivet aveugle alu / acier
3,2 x 6 ou
art. N0232060

Fortsetzung nächste Seite

continuation page suivante

HFT Fasteners AG

Bösch 37, CH-6331 Hünenberg
Telefon +41-41 780 70 01 Fax +41-41 780 73 49
Email: info@hft-fasteners.ch
Internet: www.hft-fasteners.ch



ISO 9001 Nr. 96-241-041

Blindniet Flachrundkopf

Alu / Stahl

alu / acier
Typ FAR N02

Rivet aveugle tête plate

d Ø (mm)		L	D	K	mm	Art.	Fr./100	Verp. unité
4,8 ↔ 3050 ✂ 2150 max (N)	5,0	6	10	1,1	0,5 - 2	N0248060	2.80	500
		8			2 - 4	N0248080	3.60	500
		10			4 - 6	N0248100	4.-	500
		12			6 - 8	N0248120	4.20	500
		14			8 - 10	N0248140	5.40	500
		16			10 - 12	N0248160	5.90	500
		18			12 - 14	N0248180	6.50	500
		20			14 - 16	N0248200	7.-	500
		22			16 - 18	N0248220	7.-	500
		25			18 - 21	N0248250	7.30	500
		30			21 - 24	N0248300	9.40	500
		35			24 - 29	N0248350	10.70	500
		40			29 - 34	N0248400	12.20	500
		50			41 - 46	N0248500	17.-	500
		55			45 - 50	N0248550	34.60	500
6,4 ↔ 4800 ✂ 3000 max (N)	6,5	12	12	1,8	5 - 7	N0264120	8.90	500
		15			7 - 10	N0264150	9.60	500
		18			10 - 13	N0264180	10.70	500
		22			13 - 17	N0264220	12.40	500
		26			17 - 21	N0264260	12.40	500
		30			21 - 25	N0264300	14.-	500
		35			24 - 30	N0264350	17.30	500
		40			28 - 32	N0264400	28.60	500

Bestellbeispiel:
Blindniet Alu / Stahl
6,4 x 15 oder
Art. N0264150

Exemple de commande:
Rivet aveugle alu / acier
6,4 x 15 ou
art. N0264150

HFT Fasteners AG

Bösch 37, CH-6331 Hünenberg
 Telefon +41-41 780 70 01 Fax +41-41 780 73 49
 Email: info@hft-fasteners.ch
 Internet: www.hft-fasteners.ch



ISO 9001 Nr. 96-241-041

Blindniet
Flachrundkopf
preiswert

Alu / Stahl

alu / acier
Typ ANZI N02K

Rivet aveugle
tête plate
bon prix

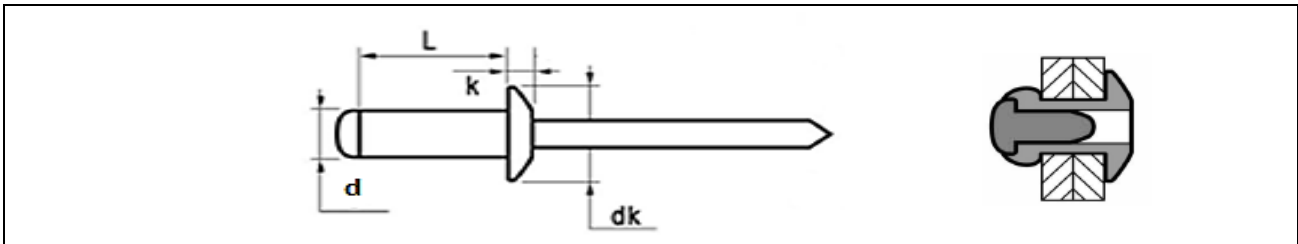

d Ø (mm)		L	dk	k	mm	Art.	Fr./100	Verp. unité
3,2	3,3	6	6,5	0,8	1,5 - 3,0	N02K32060	1.30	1000
		8			3,0 - 5,0	N02K32080	1.30	1000
		↔ 1600			5,0 - 7,0	N02K32100	1.40	1000
		⌘ 1200			7,0 - 9,0	N02K32120	1.60	1000
		max (N)			9,0 - 11,0	N02K32140	1.60	1000
					11,0 - 12,5	N02K32160	2.30	1000

4,0	4,1	12	8	1	6,0 - 8,0	N02K40120	2.30	500
		14			8,0 - 10,0	N02K40140	2.70	500
↔ 1600								
⌘ 1200								
max (N)								

4,8	4,9	8	9,5	1,1	2,0 - 3,5	N02K48080	2.30	500
		10			3,5 - 5,5	N02K48100	2.30	500
		↔ 2230			5,5 - 7,5	N02K48120	2.80	500
		⌘ 1690			9,0 - 11,0	N02K48160	3.40	500
		max (N)			29,0 - 33,5	N02K48400	12.-	500

Bestellbeispiel:
 Blindniet Alu / Stahl
 4,8 x 10 oder
 Art. N02K48100

Exemple de commande:
 Rivet aveugle alu / acier
 4,8 x 10 ou
 art. N02K48100

HFT Fasteners AG

Bösch 37, CH-6331 Hünenberg
 Telefon +41-41 780 70 01 Fax +41-41 780 73 49
 Email: info@hft-fasteners.ch
 Internet: www.hft-fasteners.ch



ISO 9001 Nr. 96-241-041

Blindniet
 Flachrundkopf

Alu / Inox

Rivet aveugle
 tête plate

Typ FAR N16

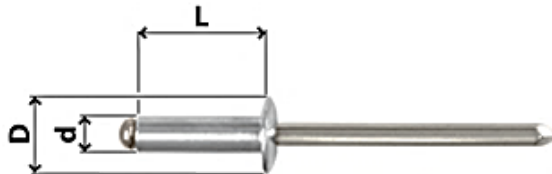

d Ø (mm)		L	D	K	mm	Art.	Fr./100	Verp. unité
4,0								
↔ 1800	4,1	12	8	1	6,5 - 8,5	N1640120	7.80	1000
⌘ 1270								
max (N)								
4,8	5,0	8	10	1,1	3,0 - 4,0	N1648080	11.20	500
		10			4,0 - 6,0	N1648100	12.20	500
↔ 2970		12			6,0 - 8,0	N1648120	12.80	500
⌘ 2180		14			8,0 - 10,0	N1648140	13.40	500
max (N)								

HFT Fasteners AG

Bösch 37, CH-6331 Hünenberg
Telefon +41-41 780 70 01 Fax +41-41 780 73 49
Email: info@hft-fasteners.ch
Internet: www.hft-fasteners.ch



ISO 9001 Nr. 96-241-041

Blindniet Flachrundkopf

Alu / Alu

Rivet aveugle tête plate

Typ FAR N01

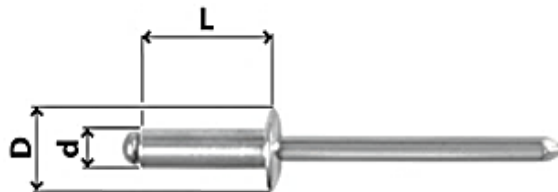

d Ø (mm)		L	D	K	mm	Art.	Fr./100	Verp. unité
3,2 ↔ 700 ✕ 400 max (N)	3,3	6	6,5	0,8	0,5 - 3,0	N0132060	2.30	1000
		8			3,0 - 5,0	N0132080	3.50	1000
		10			5,0 - 7,0	N0132100	3.90	1000
		12			7,0 - 9,0	N0132120	3.90	1000

4,0 ↔ 1200 ✕ 800 max (N)	4,1	8	8	1	2,5 - 4,5	N0140080	4.40	1000
		10			4,5 - 6,5	N0140100	4.40	500
		12			6,5 - 8,5	N0140120	5.10	500
		14			8,5 - 10,5	N0140140	5.10	500
		16			10,5 - 12,5	N0140160	5.90	500

4,8 ↔ 1500 ✕ 1000 max (N)	5,0	8	10	1,1	2,0 - 4,0	N0148080	6.60	1000
		10			4,0 - 6,0	N0148100	7.30	500
		12			6,0 - 8,0	N0148120	7.30	500
		14			8,0 - 12,0	N0148140	7.80	500
		16			10,0 - 12,0	N0148160	8.90	500
		18			12,0 - 14,0	N0148180	9.60	500

Bestellbeispiel:
Blindniet Alu / Alu
4,8 x 10 oder
Art. N0148100

Exemple de commande:
Rivet aveugle alu / alu
4,8 x 10 ou
art. N0148100

HFT Fasteners AG

Bösch 37, CH-6331 Hünenberg
 Telefon +41-41 780 70 01 Fax +41-41 780 73 49
 Email: info@hft-fasteners.ch
 Internet: www.hft-fasteners.ch





ISO 9001 Nr. 96-241-041

Blindniet Flachrundkopf

Stahl / Stahl
acier / acier
Typ FAR N03

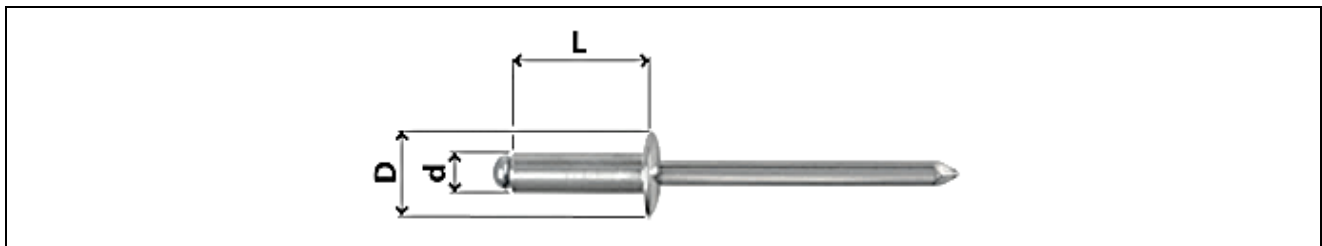
Rivet aveugle tête plate



d Ø (mm)		L	D	K	mm	Art.	Fr./100	Verp. unité
3,2 ↔ 1750 ✂ 1400 max (N)	3,3	6	6,5	0,8	0,5 - 3,0	N0332060	3.-	1000
		8			3,0 - 5,0	N0332080	3.60	1000
		10			5,0 - 7,0	N0332100	3.60	1000
		12			7,0 - 9,0	N0332120	4.40	500
4,0 ↔ 3200 ✂ 2350 max (N)	4,1	6	8	1,0	0,5 - 2,0	N0340060	2.80	1000
		8			2,0 - 4,0	N0340080	3.60	500
		10			4,0 - 6,0	N0340100	4.20	500
		12			6,0 - 8,0	N0340120	4.70	500
		14			8,0 - 10,0	N0340140	5.10	500
		16			10,0 - 12,0	N0340160	5.40	500
4,8 ↔ 3900 ✂ 3100 max (N)	5,0	8	9	1,1	2,0 - 4,0	N0348080	5.10	500
		10			4,0 - 6,0	N0348100	5.60	500
		12			6,0 - 8,0	N0348120	5.90	500
		14			8,0 - 10,0	N0348140	7.40	500
		16			10,0 - 12,0	N0348160	8.10	500
		18			12,0 - 14,0	N0348180	8.10	500
		20			14,0 - 16,0	N0348200	8.60	500
		25			16,0 - 21,0	N0348240	11.20	500
6,4 ↔ 6750 ✂ 5000 max (N)	6,5	12	12	1,8	4,0 - 7,0	N0364120	10.10	500
		15			7,0 - 10,0	N0364150	10.70	500
		18			10,0 - 13,0	N0364180	11.70	500
		22			13,0 - 16,5	N0364220	12.90	500
		26			16,5 - 20,5	N0364260	16.20	500
		30			20,5 - 24,5	N0364300	16.70	500

HFT Fasteners AG

Bösch 37, CH-6331 Hünenberg
 Telefon +41-41 780 70 01 Fax +41-41 780 73 49
 Email: info@hft-fasteners.ch
 Internet: www.hft-fasteners.ch



ISO 9001 Nr. 96-241-041

Blindniet Flachrundkopf

Inox / Inox

Rivet aveugle tête plate

Typ FAR N05

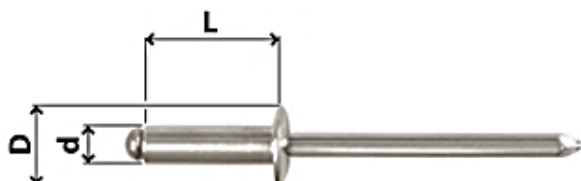

d Ø (mm)		L	D	K	mm	Art.	Fr./100	Verp. unité	
3,2	3,3	6	6,5	0,8	0,5 - 2,5	N0532060	7.80	1000	
		8			2,5 - 4,5	N0532080	9.90	1000	
		↔ 2500			4,5 - 6,5	N0532100	11.-	1000	
		✂ 2500			6,5 - 8,5	N0532120	11.80	1000	
		max (N)							
4,0	4,1	6	8,0	1,0	0,5 - 2,0	N0540060	11.70	500	
		8			2,0 - 4,0	N0540080	12.90	500	
		↔ 3500			4,0 - 6,0	N0540100	14.-	500	
		✂ 3140			6,0 - 8,0	N0540120	15.70	500	
		max (N)			14	8,0 - 10,0	N0540140	17.-	500
					16	10,0 - 12,0	N0540160	19.-	500
4,8	4,9	8	9,0	1,1	1,5 - 3,5	N0548080	18.40	500	
		10			3,5 - 5,5	N0548100	20.80	500	
		↔ 6000			5,5 - 7,5	N0548120	23.-	500	
		✂ 5200			7,5 - 9,5	N0548140	24.70	500	
		max (N)			16	9,5 - 11,5	N0548160	26.30	500
					18	11,5 - 13,5	N0548180	32.-	500
					20	13,5 - 15,5	N0548200	34.10	500
					25	15,5 - 20,5	N0548250	35.90	500
6,4	6,5	12	12		4,0 - 7,0	N0564120	53.30	500	
		15			7,0 - 10,0	N0564150	60.40	500	
		↔ 8800			10,0 - 13,0	N0564180	61.70	500	
		✂ 7000			13,0 - 17,0	N0564220	70.-	500	
		max (N)							

HFT Fasteners AG

Bösch 37, CH-6331 Hünenberg
 Telefon +41-41 780 70 01 Fax +41-41 780 73 49
 Email: info@hft-fasteners.ch
 Internet: www.hft-fasteners.ch



ISO 9001 Nr. 96-241-041

Blindniet Flachrundkopf preiswert

Inox / Inox

Rivet aveugle tête plate bon prix

Typ ANZI N05K



d Ø (mm)		L	dk	k	mm	Art.	Fr./ 100	Verp. unité
3,2 ↔ 2500 ✕ 1900 max (N)	3,3	6	6,5	0,8	1,5 - 3,0	N05K32060	5.60	1000
		8			3,0 - 5,0	N05K32080	5.60	1000
		10			5,0 - 7,0	N05K32100	5.60	1000
		12			7,0 - 9,0	N05K32120	6.60	1000
		14			9,0 - 11,0	N05K32140	7.30	1000
		16			11,0 - 12,5	N05K32160	7.30	1000
4,0 ↔ 3800 ✕ 3100 max (N)	4,1	6	8	1,0	1,0 - 2,0	N05K40060	6.60	500
		8			2,0 - 4,0	N05K40080	7.30	500
		10			4,0 - 6,0	N05K40100	7.30	500
		12			6,0 - 8,0	N05K40120	7.80	500
		14			8,0 - 10,0	N05K40140	8.90	500
		16			10,0 - 12,0	N05K40160	10.10	500
4,8 ↔ 6000 ✕ 4500 max (N)	4,9	8	9,5	1,0	2,0 - 4,0	N05K48080	9.60	500
		10			4,0 - 6,0	N05K48100	10.60	500
		12			6,0 - 8,0	N05K48120	11.20	500
		14			8,0 - 9,5	N05K48140	11.70	500
		16			9,5 - 11,0	N05K48160	12.20	500
		18			11,0 - 13,0	N05K48180	12.80	500
6,4 ↔ 8850 ✕ 6500 max (N)	6,5	12	12		3,5 - 5,5	N05K64120	32.-	500
		15			5,5 - 8,5	N05K64150	35.20	500
		18			8,5 - 11,5	N05K64180	35.20	500
		22			11,5 - 15,5	N05K64220	39.80	500

HFT Fasteners AG

Bösch 37, CH-6331 Hünenberg
 Telefon +41-41 780 70 01 Fax +41-41 780 73 49
 Email: info@hft-fasteners.ch
 Internet: www.hft-fasteners.ch

ISO 9001 Nr. 96-241-041





Blindniet
 mit Grosskopf Ø 14mm

Inox / Inox

Rivet aveugle
 avec grande tête Ø 14 mm

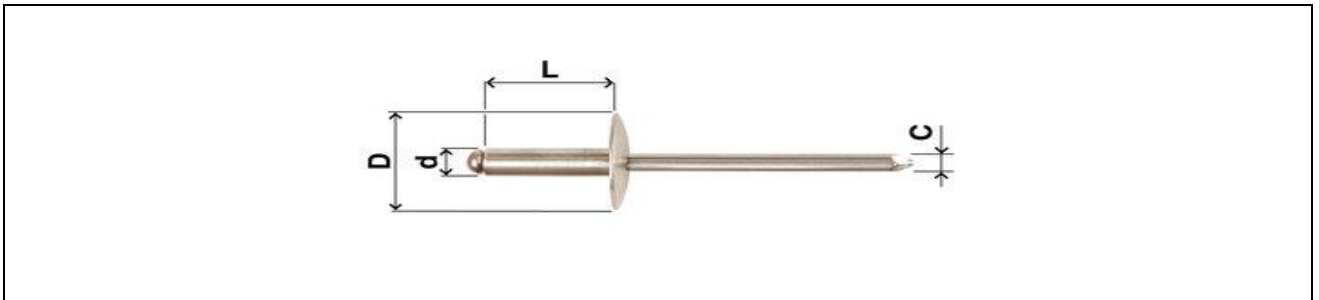
Typ FAR N58



d Ø (mm)		L	D	mm	Art.	Fr./100	Verp. unité
4,8	5	10	14	3,5 - 5,5	N5848100	26.50	500
		12		5,5 - 7,5	N5848120K14	27.90	500
↔ 6000							
✕ 5200							
max (N)							

Bestellbeispiel:
 Blindniet Inox / Inox GK14
 4,8 x 12 oder
 Art. N5848120K14

Exemple de commande:
 Rivet aveugle inox / inox gt14
 4,8 x 12 ou
 art. N5848120K14

HFT Fasteners AG

Bösch 37, CH-6331 Hünenberg
 Telefon +41-41 780 70 01 Fax +41-41 780 73 49
 Email: info@hft-fasteners.ch
 Internet: www.hft-fasteners.ch



ISO 9001 Nr. 96-241-041

Blindniet Senkkopf

Alu / Stahl

alu / acier
Typ FAR N12

Rivet aveugle tête fraisée

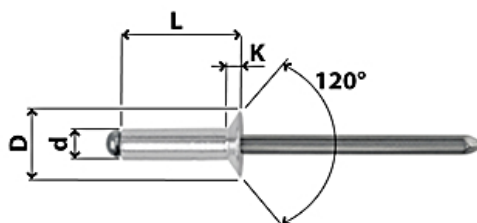

d Ø (mm)		L	D	K	mm	Art.	Fr./100	Verp. unité	
3,2	3,3	8	6,5	1,0	2 - 5	N1232080	3.10	1000	
		10			5 - 7	N1232100	3.40	1000	
		↔ 980			7 - 9	N1232120	4.-	500	
		✕ 680			9 - 11	N1232140	4.-	500	
		max (N)							
4,0	4,1	10	8	1,3	5 - 7	N1240100	3.40	500	
		12			7 - 9	N1240120	3.40	500	
		↔ 1800			9 - 11	N1240140	4.40	500	
		✕ 1200			11 - 13	N1240160	5.20	500	
					15 - 17	N1240200	5.20	500	
4,8	5,0	10	10	1,5	4 - 6	N1248100	4.40	500	
		12			6 - 8	N1248120	5.20	500	
		↔ 2900			8 - 10	N1248140	5.60	500	
		✕ 2100			(16)	10 - 12	N1248160	5.70	500
		max (N)			18	9 - 13	N1248180	5.60	500
					21	13 - 16	N1248200	6.60	500
					25	15 - 20	N1248260	7.80	500
					30	21 - 25	N1248300	8.80	500
					35	25 - 30	N1248350	8.90	500

HFT Fasteners AG

Bösch 37, CH-6331 Hünenberg
 Telefon +41-41 780 70 01 Fax +41-41 780 73 49
 Email: info@hft-fasteners.ch
 Internet: www.hft-fasteners.ch

ISO 9001 Nr. 96-241-041



Blindniet Senkkopf

Alu / Inox

Rivet aveugle tête fraisée

Typ FAR N11

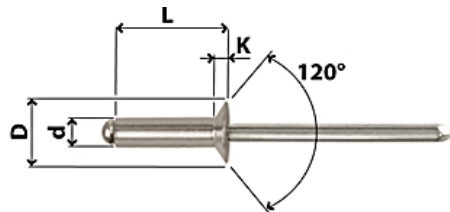

4,0 \leftrightarrow 1800 \times 1200 max (N)	4,1	8	8	1,3	3,0 - 5,0	N1140080	8.30	500
		10			5,0 - 7,0	N1140100	8.30	500
		12			7,0 - 9,0	N1140120	9.60	500
4,8 \leftrightarrow 2900 \times 2100 max (N)	4,9	10	10	1,5	4,5 - 6,0	N1148110	11.70	500
		12			6,0 - 8,0	N1148120	11.80	500
		16			10,0 - 12,0	N1148160	13.40	500

HFT Fasteners AG

Bösch 37, CH-6331 Hünenberg
Telefon +41-41 780 70 01 Fax +41-41 780 73 49
Email: info@hft-fasteners.ch
Internet: www.hft-fasteners.ch

ISO 9001 Nr. 96-241-041



Blindniet Senkkopf

Inox / Inox

Rivet aveugle tête fraisée

Typ FAR N15

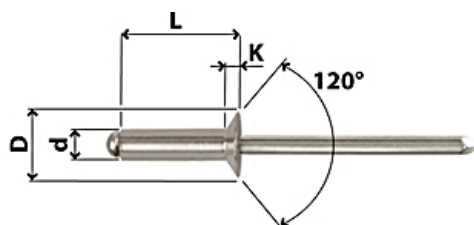

d Ø (mm)		L	D	K	mm	Art.	Fr./100.	Verp. unité
3,2	3,3	6	6,5	1,1	2,0 - 2,5	N1532060	9.60	1000
	↔	8			2,5 - 4,5	N1532080	9.80	1000
↔ 2700	3,4	10			4,5 - 6,5	N1532100	11.20	1000
⌘ 2350		12			7.0 - 9.0	N1532120	15.60	500
max (N)								

4,0	4,1	8	8	1,3	3,0 - 4,0	N1540080	15.20	500
		10			4,0 - 6,0	N1540100	15.70	500
↔ 4200		12			6,0 - 8,0	N1540120	18.-	500
⌘ 3650		14			8,0 - 10,0	N1540140	18.40	500
max (N)								

4,8	5,0	10	10	1,5	3,5 - 5,5	N1548100	10.-	500
		12	9,5		5,5 - 7,5	N1548120	11.50	500
↔ 6000		14			7,5 - 9,5	N1548140	12.-	500
⌘ 5200		16			8,0 - 11,0	N1548160	12.50	500
max (N)		18			10,0 - 13,0	N1548180	13.-	500

Bestellbeispiel:
Blindniet Senkkopf
Inox / Inox
4,0 x 8 oder
Art. N1540080

Exemple de commande:
Rivet aveugle tête fraisée
inox / inox
4,0 x 8 ou
art. N1540080

HFT Fasteners AG

Bösch 37, CH-6331 Hünenberg
 Telefon +41-41 780 70 01 Fax +41-41 780 73 49
 Email: info@hft-fasteners.ch
 Internet: www.hft-fasteners.ch



ISO 9001 Nr. 96-241-041

Blindniet

Senkkopf
 grosser Klemmbereich

Alu / Stahl Multi

alu / acier Multi
 Typ FAR N22

Rivet aveugle

tête fraisée
 grande gamme de serrage

Sauberer Schliesskopf
 Hohe Klemmkraft
 Grosse Bohrlochtoleranzen
 Prüfzeugnisse auf Anfrage.

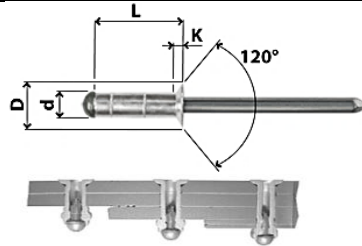

fermeture très propre
 grande force d'assemblage
 grande tolérance de forage
 bulletins d'expertise sur demande.

d Ø (mm)		L	D	K	mm	Art.	Fr./100	Verp. unité
3,2	3,3 ↔ 3,4	10	6	0,8	2,4 - 6,4	N2232100	4.-	500
↔ 1000 ⊗ 880 max (N)								
4,0	4,1 ↔ 4,2	11	6,5	0,9	2,8 - 7,9	N2240110	5.60	500
↔ 1600 ⊗ 1200 max (N)								
4,8	5,0 ↔ 5,1	11 17	8,5	1,1	3,2 - 7,9 6,4 - 12,7	N2248110 N2248170	6.10 8.50	500 500
↔ 2200 ⊗ 1600 max (N)								

Bestellbeispiel:
 Alu / Stahl Multi Senkkopf
 3,2 x 10 oder
 Art. N2232100

Exemple de commande:
 alu / acier Multi tête fraisée
 3,2 x 10 ou
 art. N2232100

HFT Fasteners AG

Bösch 37, CH-6331 Hünenberg
 Telefon +41-41 780 70 01 Fax +41-41 780 73 49
 Email: info@hft-fasteners.ch
 Internet: www.hft-fasteners.ch



ISO 9001 Nr. 96-241-041

Blindniet

Flachrundkopf
 grosser Klemmbereich

Alu / Stahl Multi

alu / acier Multi
 Typ FAR N08

Rivet aveugle

tête plate
 grande gamme de serrage



d Ø (mm)		L	D	K	mm	Art.	Fr./100	Verp. unité
3,2	3,4	8	6,5	0,8	0,8 - 4,8	N0832080	3.20	1000
		11,5			4,0 - 8,0	N0832115	3.60	1000
↔ 1000								
⌘ 800								
max (N)								

4,0	4,2	10	8	1	1,2 - 6,5	N0840100	4.-	500
		13			4,0 - 9,5	N0840130	4.50	500
		17			6,4 - 12,7	N0840170	5.60	500
↔ 1600								
⌘ 1200								
max (N)								

4,8	5,1	11	10	1,1	1,3 - 6,5	N0848110	4.90	500
		15			4,8 - 11,1	N0848150	5.60	500
		17			5,5 - 12,0	N0848170	7.-	500
		25			12,7 - 19,8	N0848250	10.10	500
↔ 2200								
⌘ 1600								
max (N)								

mit Grosskopf Ø 16 mm

Typ FAR N28

avec tête grande Ø 16 mm

4,8	4,9	10	16	1,5	1,6 - 6,4	N2848100	7.30	500
		↔ 16			6,4 - 12,7	N2848160	8.90	500
	↔ 2200	5,1			25	12,7 - 18,8	N2848250	11.8s0
⌘ 1600								
max (N)								

Bestellbeispiel
 Blindniet Alu / Stahl, Multi, Grosskopf 16
 4,8 x 16 oder
 Art. N2848160

Exemple de commande
 Rivet alu / acier, Multi, tête 16
 4,8 x 16 ou
 Art. N2848160

HFT Fasteners AG

Bösch 37, CH-6331 Hünenberg
 Telefon +41-41 780 70 01 Fax +41-41 780 73 49
 Email: info@hft-fasteners.ch
 Internet: www.hft-fasteners.ch



ISO 9001 Nr. 96-241-041

Blindniet

Flachrundkopf
 grosser Klemmbereich

Alu / Inox Multi

Typ FAR N18

Rivet aveugle

tête plate
 grande gamme de serrage

Der grosse Klemmbereich kann bis zu vier Nietenlängen ersetzen.

La grande gamme de serrage peut remplacer jusqu'à 4 longueurs standard.

d Ø (mm)		L	D	K	mm	Art.	Fr./100	Verp. unité			
3,2	3,3	8	6,5	0,8	1,0 - 4,8	N1832080	7.30	1000			
	↔	11,5							4,0 - 8,0	8.30	1000
	↔ 1000 ✂ 800 max (N)	3,4									

4,0	4,1	10	8	1,3	1,2 - 6,5	N1840100	10.10	500				
	↔	13							4,0 - 9,5	N1840130	11.20	500
	↔ 1600 ✂ 1200 max (N)	4,2							17	6,4 - 12,7	N1840170	12.20

4,8	4,9	11	10	1,45	1,3 - 6,5	N1848110	14.60	500					
	↔	15							4,8 - 11,1	N1848150	16.20	500	
	↔ 2250	5,1							17	5,5 - 12,0	N1848170	17.20	500
	✂ 1600 max (N)	25							12,0 - 18,0	N1848250	20.80	500	

mit Grosskopf Ø 16 mm

Typ FAR N19

avec grande tête Ø 16 mm

4,8	4,9	10	16	1,8	1,5 - 6,0	N1948100	15.-	500				
	↔	16							6,4 - 12,7	N1948160	17.-	500
	↔ 2250 ✂ 1600 max (N)	5,1							25	13,0 - 20,0	N1948250	26.-

Bestellbeispiel:
 Blindniet Alu / Inox Multi
 Grosskopf 16
 4,8 x 10 oder
 Art. N1948100

Exemple de commande:
 Rivet aveugle alu / inox Multi
 grande tête 16
 4,8 x 10 ou
 art. N1948100

HFT Fasteners AG

Bösch 37, CH-6331 Hünenberg
 Telefon +41-41 780 70 01 Fax +41-41 780 73 49
 Email: info@hft-fasteners.ch
 Internet: www.hft-fasteners.ch

ISO 9001 Nr. 96-241-041



Blindniet

mit gerilltem Dorn
 grosser Klemmbereich





Inox / Inox Multi

Typ FAR N58

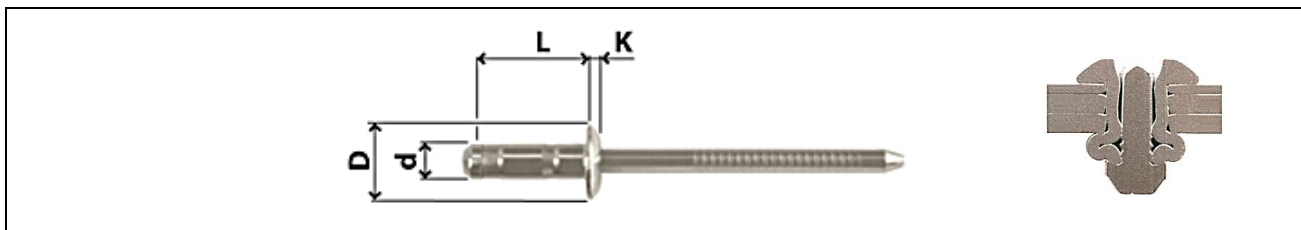
Rivet aveugle

avec mandrin reillé
 grande gamme de serrage



d Ø (mm)		L	D	K	mm	Art.	Fr./100	Verp. unité
3,2 ↔ 2500 ⌘ 2000-3800 max (N)		7	6,5	1,0	1,0 - 3,0	N5832070	12.40	1000
		9			3,0 - 5,0	N5832090	13.50	1000
		11			5,0 - 7,0	N5832110	16.50	1000
4,0 ↔ 3700 ⌘ 3500-5100 max (N)		7	8	1,3	1,2 - 3,0	N5840070	17.90	500
		9			3,0 - 5,0	N5840090	20.10	500
		12			5,0 - 7,0	N5840120	21.80	500
4,8 ↔ 5000 ⌘ 5000-6900 max (N)		9	10	1,5	1,5 - 3,5	N5848090	33.50	500
		12			3,5 - 6,0	N5848120	37.10	500
		15			6,0 - 8,5	N5848150	39.80	500

Der Scher-**Höchstwert** entspricht der Prüfung mit Nietdorn im Scherbereich (min. Kl.bereich).

La valeur de cisaillement **supérieure** correspond à l'essai **avec le mandrin** lors de la rupture.

Der Scher-**Mindestwert** entspricht der Prüfung ohne Nietdorn im Scherbereich.

La valeur de cisaillement **inférieure** correspond à l'essai **sans le mandrin** lors de la rupture.

Bestellbeispiel:
 Blindniet Inox / Inox Multi
 4,8 x 12 oder Art. N5848120

Exemple de commande:
 Rivet aveugle inox / inox Multi
 4,8 x 12 ou art. N5848120

HFT Fasteners AG

Bösch 37, CH-6331 Hünenberg
 Telefon +41-41 780 70 01 Fax +41-41 780 73 49
 Email: info@hft-fasteners.ch
 Internet: www.hft-fasteners.ch



ISO 9001 Nr. 96-241-041

Multi Blindniet

Inox / Inox PLUS

Multi Rivet aveugle

grosser Klemmbereich

Typ FAR N55

grande gamme de serrage

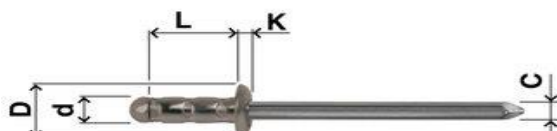

d Ø (mm)		L	D	K	mm	Art.	Fr./100	Verp. unité
3,2								
↔ 1800 ⌘ 1800 max (N)	3,4	11	6,5	1,0	1,0 - 6,0	N5532110	13.70	1000

d Ø (mm)		L	D	K	mm	Art.	Fr./100	Verp. unité
4,0								
↔ 3000 ⌘ 2700 max (N)	4,2	12	8	1,3	2,0 - 8,0	N5540120	18.90	500

d Ø (mm)		L	D	K	mm	Art.	Fr./100	Verp. unité
4,8								
↔ 4500 ⌘ 4000 max (N)	5,1	15	10	1,8	1,5 - 9,0	N5548150	31.50	500

Grosser Klemmbereich
 Eine einzige Länge überbrückt den
 Klemmbereich mehrerer Standard-Blindnieten
 Gleicht das Vorhandensein von
 unregelmässigen Bohrungen aus.
 Fixierter Nietdorn.

Grande épaisseur de serrage
 Une seule longueur couvre l'épaisseur de
 serrage de plusieurs rivets standard
 Compense la présence de trous irréguliers.
 Clou à retenue.

HFT Fasteners AG

Bösch 37, CH-6331 Hünenberg
 Telefon +41-41 780 70 01 Fax +41-41 780 73 49
 Email: info@hft-fasteners.ch
 Internet: www.hft-fasteners.ch



ISO 9001 Nr. 96-241-041

Blindniet

grosser Klemmbereich
mit gerilltem Dorn

Stahl / Stahl Multi-Tamp

acier / acier Multi-Tamp
Typ FAR N23

Rivet aveugle

grande gamme de serrage
avec mandrin reillé

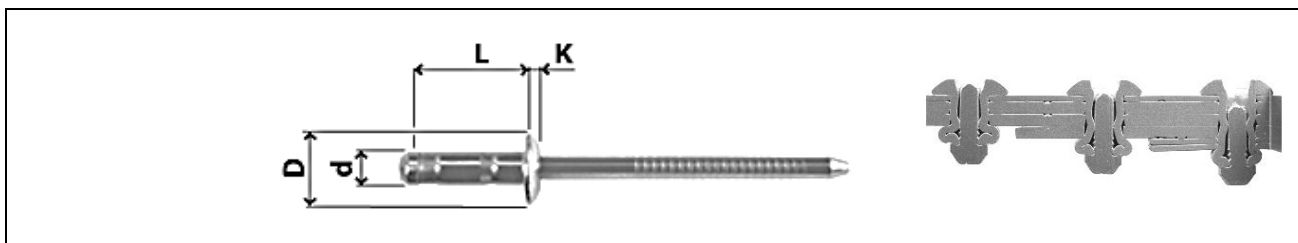

d Ø (mm)		L	D	K	mm	Art.	Fr./100	Verp. unité
3,2	3,4	7	6,5	1,0	1,0 - 3,0	N2332070	5.30	1000
		9			3,0 - 5,0	N2332090	6.-	1000
		11			5,0 - 7,0	N2332110	7.-	1000
↔ 1482								
⊗ 1130-2600								
max (N)								
4,0	4,2	7	8	1,3	1,2 - 3,0	N2340070	5.-	500
		9			3,0 - 5,0	N2340090	6.-	500
		12			5,0 - 7,0	N2340120	7.-	500
↔ 2166								
⊗ 1947-3819								
max (N)								
4,8	5,1	9	10	1,5	1,5 - 3,5	N2348090	7.70	500
		12			3,5 - 6,0	N2348120	9.20	500
		15			6,0 - 8,5	N2348150	11.60	500
↔ 4199								
⊗ 2793-6650								
max (N)								

Der Scher-**Höchstwert** entspricht der Prüfung mit Nietdorn im Scherbereich (min. Kl.bereich).

La valeur de cisaillement **supérieure** correspond l'essai **avec le mandrin** lors de la rupture.

Der Scher-**Mindestwert** entspricht der Prüfung **ohne** Nietdorn im Scherbereich.

La valeur de cisaillement **inférieure** correspond à l'essai **sans le mandrin** lors de la rupture.

Bestellbeispiel: Blindniet Tamp
Stahl / Stahl Multi 4.8 x 12 oder
Art. N2348120

Exemple de commande:
Rivet aveugle Tamp
acier / acier Multi 4,8 x 12 ou art. N2348120

HFT Fasteners AG

Bösch 37, CH-6331 Hünenberg
 Telefon +41-41 780 70 01 Fax +41-41 780 73 49
 Email: info@hft-fasteners.ch
 Internet: www.hft-fasteners.ch



ISO 9001 Nr. 96-241-041

Becher-Dichtniet

Flachrundkopf

Alu / Stahl

alu / acier
 Typ FAR N17

Rivet étanche

tête plate

Der Becher- Dicht-Blindniet hat ein geschlossenes Schaftende und der Dornkopf ist unverlierbar im Nietschaft eingebettet. Dadurch entsteht eine luft- und wasserdichte Nietverbindung.

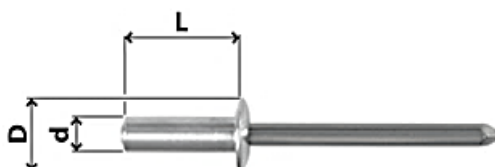

Le rivet étanche est complètement fermé et le mandrin y est renfermé de manière étanche.

d Ø (mm)		L	D	K	mm	Art.	Fr./100	Verp. unité
3,2	3,3	7,5	6	1,3	1,5 - 3,5	N1732075	3.40	500
		9,0			3,5 - 4,5	N1732090	3.40	500
		↔ 1500			4,5 - 6,0	N1732105	4.-	500
		✂ 1000			6,0 - 8,0	N1732120	4.40	500
max (N)								

4,0	4,1	8,0	8	1,7	0,8 - 3,5	N1740080	4.70	500
		9,5			3,5 - 5,5	N1740095	5.10	500
		↔ 2100			6,4 - 7,5	N1740130	8.90	500
		✂ 1500			7,5 - 9,5	N1740140	8.90	500
max (N)								

4,8	5,0	10,0	9,5	2,0	3,5 - 5,0	N1748100	6.30	500	
		11,5			5,0 - 6,0	N1748115	6.60	500	
		↔ 3000			6,0 - 7,5	N1748130	7.-	500	
		✂ 2300			7,5 - 9,0	N1748145	7.-	500	
		max (N)			16,5	9,0 - 10,5	N1748165	7.80	500
					18,0	10,5 - 12,5	N1748180	8.30	500
22,0									
12,5 - 18,0									
N1748220									
8.90									
500									

mit Senkkopf

Typ FAR N27

à tête fraisée

4,8	5,0	11,5	9,5	2,0	3,5 - 6,5	N2748115	7.80	500
		14,5			6,5 - 9,0	N2748145	8.30	500
		↔ 3100			9,0 - 11,5	N2748180	10.10	500
		✂ 2650						
max (N)								

HFT Fasteners AG

Bösch 37, CH-6331 Hünenberg
 Telefon +41-41 780 70 01 Fax +41-41 780 73 49
 Email: info@hft-fasteners.ch
 Internet: www.hft-fasteners.ch



ISO 9001 Nr. 96-241-041

Becher-Dichtniet Flachrundkopf

Alu / Inox

Rivet étanche tête plate

Typ FAR N07

Der Becher- Dicht-Blindniet hat ein geschlossenes Schaftende und der Dornkopf ist unverlierbar im Nietschaft eingebettet. Dadurch entsteht eine luft- und wasser-dichte Nietverbindung.

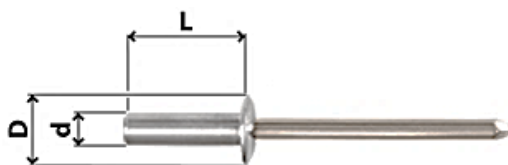

Le rivet étanche est complètement fermé et le mandrin y est renfermé de manière étanche.

d Ø (mm)		L	D	K	mm	Art.	Fr./100	Verp. unité
3,2		8,0	6	1,3	2,0 - 3,5	N0732075	7.30	500
		9,5			3,5 - 5,0	N0732090	8.90	500
		12,5			6,5 - 8,0	N0732125	8.90	500
					-			
↔ 1300								
✂ 1000								
max (N)								

4,0		8,0	8	1,7	0,5 - 3,5	N0740080	9.50	500
		9,5			3,5 - 5,0	N0740095	10.10	500
		12,5			6,5 - 8,0	N0740120	10.70	500
↔ 2100								
✂ 1500								
max (N)								

4,8		8	9,5	2,0	1,0 - 3,5	N0748085	12.20	500
		11,0			4,5 - 6,0	N0748115	14.-	500
		14,0			7,5 - 9,0	N0748145	15.20	500
		18,0			11,0 - 13,0	N0748180	19.-	500
↔ 3000								
✂ 2000								
max (N)								

Bestellbeispiel:
 Becher- Dichtniet Alu / Inox
 4,8 x 18 oder
 Art. N0748180

Exemple de commande:
 Rivet étanche alu / inox
 4,8 x 18 ou
 art. N0748180

Becherniete Stahl /Stahl

Rivets étanches acier /acier

d Ø (mm)		L	D	K	mm	Art.	Fr./100	Verp. unité
3,2		9,5	6	1,3	3,0 - 5,0	N1332095	8.60	500
		12			5,0 - 6,5	N1332120	9.-	500

HFT Fasteners AG

Bösch 37, CH-6331 Hünenberg
 Telefon +41-41 780 70 01 Fax +41-41 780 73 49
 Email: info@hft-fasteners.ch
 Internet: www.hft-fasteners.ch



ISO 9001 Nr. 96-241-041

Becher-Dichtniet Flachrundkopf

Inox / Inox

Rivet étanche tête plate

Typ FAR N57

Der Becher- Dicht-Blindniet hat ein geschlossenes Schaftende und der Dornkopf ist unverlierbar im Nietschaft eingebettet. Dadurch entsteht eine luft- und wasserdichte Nietverbindung.

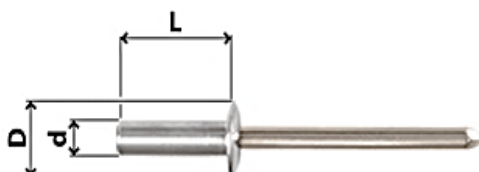

Le rivet étanche est complètement fermé et le mandrin y est renfermé de manière étanche.

d Ø (mm)		L	D	K	mm	Art.	Fr./100	Verp. unité
3,2	3,3	8	6	1,3	0,5 - 2,5	N5732080	17.-	500
		10			2,5 - 4,5	N5732100	19.50	500
		↔ 2350			4,5 - 7,0	N5732120	22.-	500
		∞ 2200						
max (N)								
4,0	4,1	8	8	1,7	0,5 - 3,0	N5740080	23.-	500
		10			3,0 - 5,0	N5740095	24.50	500
		↔ 4400			5,0 - 7,0	N5740120	26.-	500
		∞ 4000			7,0 - 9,0	N5740140	27.-	500
		max (N)			6,5 - 10,5	N5740160	28.-	500
4,8	5,0	8	9,5	2,0	0,5 - 2,0	N5748080	29.60	500
		10			2,0 - 4,0	N5748100	30.70	500
		↔ 8000			5,0 - 6,5	N5748120	32.60	500
		max (N)			6,5 - 10,5	N5748160	35.90	500

Bestellbeispiel:
 Becher-Dichtniet Inox / Inox
 4,8 x 16 oder
 Art. N5748160

Exemple de commande:
 Rivet étanche inox / inox
 4,8 x 16 ou
 art. N5748160

HFT Fasteners AG

Bösch 37, CH-6331 Hünenberg
 Telefon +41-41 780 70 01 Fax +41-41 780 73 49
 Email: info@hft-fasteners.ch
 Internet: www.hft-fasteners.ch



ISO 9001 Nr. 96-241-041

Spenglerniet

Cu-Ni / Inox
 zum Verlöten geeignet

CRNI - Inox / Inox

Typ N04

Rivet ferblantier

Cu-Ni / Inox
 peut être sudé(brasé)

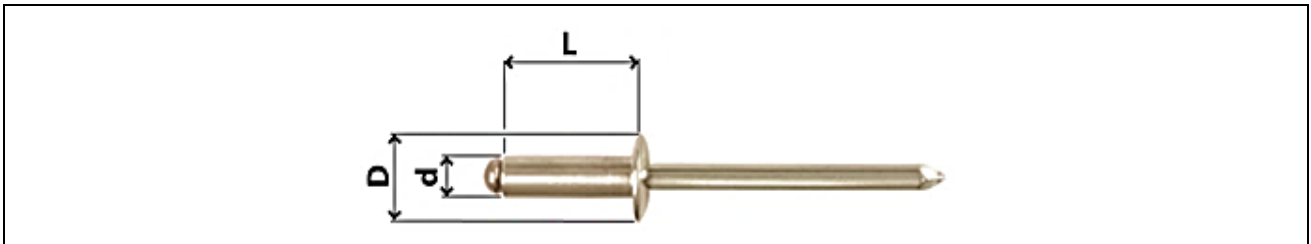

d Ø (mm)		L	D	K	mm	Art.	Fr./100	Verp. unité	
3,2 ↔ 2050 ✕ 1100 max (N)	3,3	CRNI-1	5	6,0	0,8	0,5 - 2,0	N0432050	10.20	1000
		CRNI-2	6			1,5 - 3,0	N0432060	10.20	1000
		CRNI-3	7			3,0 - 4,0	N0432070	10.70	1000
		CRNI-4	9			4,0 - 6,0	N0432090	12.10	500
		CRNI-5	12			8,0 - 9,0	N0432120	14.-	500
		CRNI-6	15			8,0 - 11,0	N0432150	15.10	500

Spenglerniet

Kupfer / Messing

CB - Kupfer / Bronze

Typ N14

Rivet ferblantier

Tige cuivre / Messing

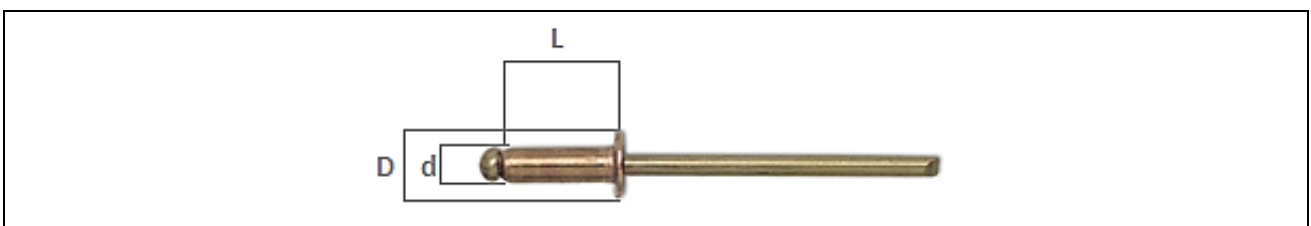

d Ø (mm)		L	D	K	mm	Art.	Fr./100.	Verp. unité
3,2 ↔ 1130 ✕ 880 max (N)	3,3	5	6	0,8	0,5 - 2,0	CB- 1 (N1433205)	9.20	1000
		6			2,0 - 3,0	CB- 2 (N1433206)	9.20	1000
		7			3,0 - 4,0	CB- 3 (N1433207)	9.60	1000
		9			4,0 - 6,0	CB- 4 (N1433209)	10.90	500
		12			6,0 - 9,0	CB- 5 (N1433212)	12.10	500
		15			9,0 - 12,0	CB- 6 (N1433215)	13.10	500

HFT Fasteners AG

Bösch 37, CH-6331 Hünenberg
 Telefon +41-41 780 70 01 Fax +41-41 780 73 49
 Email: info@hft-fasteners.ch
 Internet: www.hft-fasteners.ch



ISO 9001 Nr. 96-241-041

Sternniet

Alu / Stahl

alu / acier
 Typ FAR N09

Rivet étoile

Der **Sternniet** eignet sich speziell für die Vernietung von weichen und spröden Materialien wie (Kunststoff, Holz, Schaumstoff etc). Die am Dornknopf befindlichen Schneidekanten schlitzten den Nietschaft während des Setzvorgangs so auf, dass eine grossflächige sternförmige Verformung auf der Blindseite entsteht.



Avec grande tête. Pour assembler des plaques en bois, plastique ou autres matières tendres.

d Ø (mm)		L	D	K	mm	Art.	Fr./100	Verp. Unité	
4,0	4,3	16	8	1,3	6,0 - 10,0	N0940160	6.20	500	
↔ 1250		20			10,0 - 14,0	N0940200	6.60	500	
✂ 1450									
max (N)									

4,8	5,3	12	10	1,1	2,0 - 6,0	N0948120	6.20	500
		16			6,0 - 10,0	N0948160	8.20	500
↔ 2000		20			10,0 - 14,0	N0948200	10.20	500
✂ 2150		25			14,0 - 18,0	N0948250	11.30	500
max (N)		45			32,0 - 37,0	N0948450	21.20	500

6,4	7,0	18	12		3,0 - 7,0	N0964180	15.60	500
		22		7,0 - 11,0	N0964220	17.30	500	
↔ 3000		26		11,0 - 15,0	N0964260	17.90	500	
✂ 3000		30		15,0 - 20,0	N0964300	20.80	500	
max (N)								

Inox / Inox

Typ N10

4,8								
↔ 1000	6,0	16	9,5	1,1	6,0 - 10,0	N1048160	122.-	500
✂ 4500								
max (N)								

HFT Fasteners AG

Bösch 37, CH-6331 Hünenberg
 Telefon +41-41 780 70 01 Fax +41-41 780 73 49
 Email: info@hft-fasteners.ch
 Internet: www.hft-fasteners.ch



ISO 9001 Nr. 96-241-041

Blindniet

mit grossem Schliesskopf
 + Dichtscheibe

BULB TITE

Rivet aveugle

avec grande surface
 + rondelle étanche

Beste Abdichtung dank
 Neopren-Scheibe.

Grosser Klemmbereich.
 Für die Verbindungen von
 weichen oder Druck
 empfindliche Materialien.

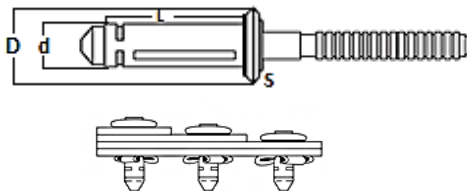

Très bonne étanchéité avec
 joint néoprène.

Grande gamme de serrage.
 Pour l'assemblage de matières
 souples ou ne supportant pas
 grande pression.

Alu / Alu

d Ø (mm)		L	D	S	mm	Art.	Fr./100	Verp. unité
5,2 mit Dichtung avec rondelle d'étanchéité ↔ 2000 ⌘ 3300 max (N)	5,4	W3 - 17,5	11,5	2,2	0,5 - 4,8	10340003	51.50	1000
		W4 - 19,1			1,5 - 6,4	10340004	52.-	1000
		W6 - 22,2			4,8 - 9,5	10340006	53.50	1000
		W8 - 25,4			7,9 - 12,7	10330008	55.-	1000
		W10 - 28,6			11,1 - 15,9	10330010	56.50	500
		W12 - 31,8			14,3 - 19,1	10330012	58.-	500

**Wasserdicht, vibrationsfest,
 mit grossem Klemmbereich.**

**Étanche, résistant aux vibrations
 grande gamme de serrage.**

4,8 mit Dichtung avec rondelle d'étanchéité ↔ 1700 ⌘ 2400 →← 300 max (N)	5,2	26	11,5	3	1,3 - 7,9	MTPB65S	63.40	500
	↔ 5.5							

6.1 mit Dichtung avec rondelle d'étanchéité ↔ 2600 ⌘ 4200 →← 300 max (N)	6,4	28	13,5	3	3,2 - 9,5	MTPB86S	81.40	500
	↔ 6,6							

HFT Fasteners AG

Bösch 37, CH-6331 Hüenenberg
 Telefon +41-41 780 70 01 Fax +41-41 780 73 49
 Email: info@hft-fasteners.ch
 Internet: www.hft-fasteners.ch



ISO 9001 Nr. 96-241-041

Fassaden-Niet

mit Grosskopf ø 14 mm
 z.B. für ALUCOBOND

Alu / Inox

Typ FAR N16A

Rivet façades

avec grande tête ø 14 mm
 p.ex. pour ALUCOBOND

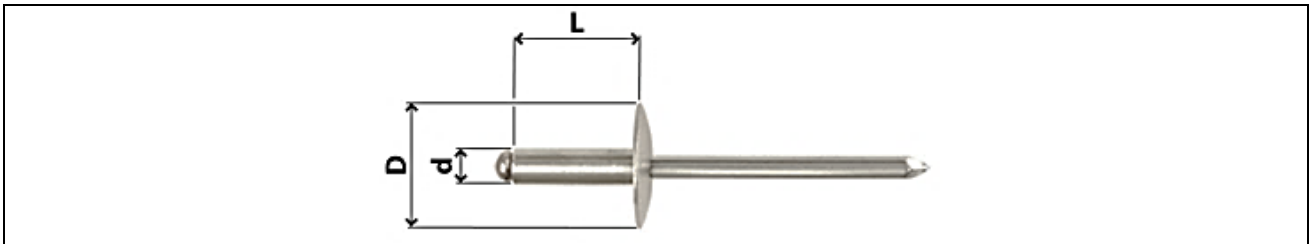

d Ø (mm)		L	D	K	mm	Art.	Fr./100	Verp. unité
5,0	5,1	12	14	1,5	6,0 - 8,0	N1650120	17.30	500
↔ 3100		14			7,5 - 10,0	N1650140	18.-	500
⊗ 2150		18			11,5 - 13,5	N1650180	23.20	250
max (N)		20			13,0 - 15,5	N1650200	25.-	250

auf Anfrage auch in den Alucobond
 Standardfarben erhältlich!

Sur demande disponible en
 Alucobond couleurs standard!

Dilatationsmundstück zu AccuBird für Alucobond 16-er Nietkopf, Tiefenanschlag zu Stufenbohrer Pelicolor 5.1 x 8 mm und 4.9 x 8 mm

Buse dilatation pour AccuBird pour Alucobond tête rivet 16 mm, came de butée pour forets Pelicolor 5.1 x 8 mm et 4.9 x 8 mm

Hammerschlagniet

Alu / Inox

Rivet à marteau

d Ø (mm)		L	D1	K	mm	Art.	Fr./100.	Verp. unité
4,8	5,0	35	15,5	2	29,0 - 31,0	AVT48350	23.40	250
↔ 1900								
⊗ 3500								
max (N)								

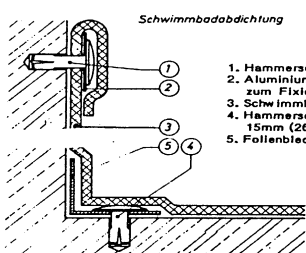

- Schwimmbadabdichtung**
1. Hammerschlag-Niet
 2. Aluminium 1 x 20 mm zum Fixieren
 3. Schwimmbedfolle
 4. Hammerschlag-Niet 15mm (26mm)
 5. Folienblech

Bestellbeispiel:
 Avdel Hammerschlagniet Alu/Inox
 Code 5161-0697 oder
 4,8 x 25,4 mm

Exemple de commande:
 Avdel rivet à marteau alu/inox
 code 5161-0697 ou
 4,8 x 25,4 mm

Mit einem Schlag schnelle und sichere Befestigung von:

- Alu- und Blechprofilen
- Wandanschlußprofilen
- Dachrandprofilen
- Kaminabdichtungen
- Mauerabdeckungen
- Lichtkuppeln
- Dachdichtungsbahnen
- Flanschbefestigungen
- usw.

auf:

- Mauerwerk
- Holz
- Unterkonstruktionen bei DACH und WAND!

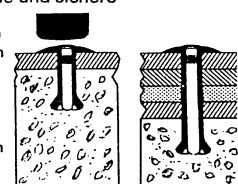

HFT Fasteners AG

Bösch 37, CH-6331 Hünenberg
 Telefon +41-41 780 70 01 Fax +41-41 780 73 49
 Email: info@hft-fasteners.ch
 Internet: www.hft-fasteners.ch



ISO 9001 Nr. 96-241-041

Gerillter Niet

(Sackloch-Niet)

Alu / Stahl

alu / acier
 Typ FAR N06

Rivet cannelé

(Rivet pour cul-de-sac)

Für Nietungen in volles Material oder Holz und Kunststoff. Der gerillte Schaft krallt sich in der Bohrlochwand fest.

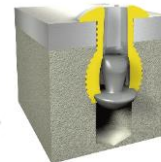
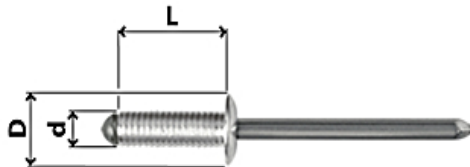

Pour rivetages dans matières pleines ou bois et plastiques. Le rivet s'accroche aux parois du trou.

d Ø (mm)		L	D	K	mm	Art.	Fr./100	Verp. unité
5,0	5,2	10	9,5	1,1	bis 6	N0650100	4.50	500
↔ 2350		18			bis 13	N0650180	8.50	250
⊗ 1960		26			bis 20	N0650260	10.-	250
max (N)								

HFT Fasteners AG

Bösch 37, CH-6331 Hünenberg
Telefon +41-41 780 70 01 Fax +41-41 780 73 49
Email: info@hft-fasteners.ch
Internet: www.hft-fasteners.ch

ISO 9001 Nr. 96-241-041



Auf den nachfolgenden Seiten
34 – 46 folgen

Blindnietmuttern

Sur les pages 34 – 46
suivantes voici les

Inserts filetés

HFT Fasteners AG

Bösch 37, CH-6331 Hünenberg
 Telefon +41-41 780 70 01 Fax +41-41 780 73 49
 Email: info@hft-fasteners.ch
 Internet: www.hft-fasteners.ch



ISO 9001 Nr. 96-241-041

FTT Aluminium

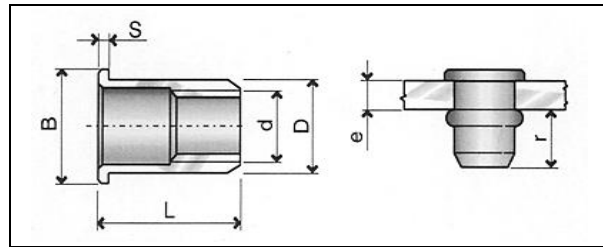

Blindnietmuttern Flachkopf

Insert fileté à tête cylindrique

Typ	M	e	r min/max	δ	D	B	S	L	Art.	Fr./100
FTT/C	3	0.3 - 1.8	4.2/4.6	5	4.9	7	0.8	9	FA620030	12.20
FTT/L	3	1.8 - 3.0	4.2/4.6	5	4.9	7	0.8	10.5	FA620032	12.20
FTT/C	4	0.3 - 2.5	5.5/6.0	6	5.9	9	1	11	FA620040	10.60
FTT/L	4	2.5 - 4.0	5.5/6.0	6	5.9	9	1	13	FA620042	14.-
FTT/C	5	0.5 - 2.3	7.2/7.7	7	6.9	10	1.2	13	FA620050	11.20
FTT/L	5	3.0 - 5.0	7.2/7.7	7	6.9	10	1.2	15.5	FA620051	14.50
FTT/C	6	0.5 - 2.3	7.6/8.2	9	8.9	12	1.5	14.5	FA620060	19.-
FTT/M	6	2.3 - 4.0	7.6/8.2	9	8.9	12	1.5	16	FA620061	19.-
FTT/L	6	4.0 - 6.0	7.6/8.2	9	8.9	12	1.5	17.5	FA620062	19.-
FTT/C	8	0.8 - 3.5	9.1/10.1	11	10.9	15	1.5	17.5	FA620080	17.90
FTT/L	8	3.5 - 6.0	9.1/10.1	11	10.9	15	1.5	20	FA620082	17.90
FTT/C	10	1.0 - 3.5	-	13	12.9	19	2.1	17	FA620010	27.90
FTT/L	10	3.0 - 6.0	-	13	12.9	17	2.1	22	FA6210220	29.60

HFT Fasteners AG

Bösch 37, CH-6331 Hüenenberg
 Telefon +41-41 780 70 01 Fax +41-41 780 73 49
 Email: info@hft-fasteners.ch
 Internet: www.hft-fasteners.ch



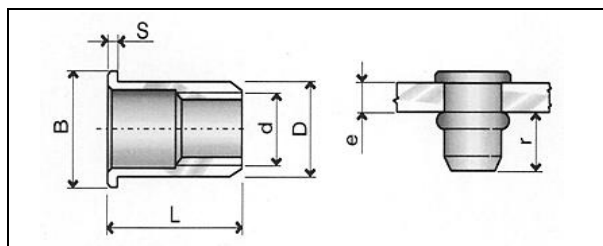

ISO 9001 Nr. 96-241-041

FTT Stahl v. / acier z.



Blindnietmuttern Flachkopf

Insert fileté à tête cylindrique

Typ	M		r min/max		D	B	S	L	Art.	Fr./100
FTT/C	3	0.3 - 1.8	4.2/4.6	5	4.9	7	0.8	9	FA610030	11.20
FTT/L	3	1.8 - 3.0	4.2/4.6	5	4.9	7	0.8	10.5	FA610032	12.20
FTT/C	4	0.3 - 2.5	5.5/6.0	6	5.9	9	1	11	FA610040	12.30
FTT/L	4	2.5 - 4.0	5.5/6.0	6	5.9	9	1	13	FA610042	13.40
FTT/C	5	0.5 - 3.0	7.2/7.7	7	6.9	10	1.2	13	FA610050	12.60
FTT/L	5	3.0 - 5.0	7.2/7.7	7	6.9	10	1.2	15.5	FA610051	14.80
FTT/C	6	0.5 - 3.0	7.6/8.2	9	8.9	12	1.5	14.5	FA610060	13.40
FTT/L	6	3.0 - 5.5	7.6/8.2	9	8.9	12	1.5	17.5	FA610062	18.40
FTT/C	8	0.8 - 3.5	9.5/10.1	11	10.9	15	1.5	17.5	FA610080	16.20
FTT/L	8	3.5 - 6.0	9.5/10.1	11	10.9	15	1.5	20	FA610082	16.20
FTT/C	10	1.0 - 3.5	12.5/13.5	13	12.9	17	1.7	21	FA610100	23.40
FTT/L	10	3.5 - 6.0	12.5/13.5	13	12.9	17	1.7	24	FA610102	34.10
FTT/C	12	1.0 - 4.0	12.5/13.5	15	14.9	20	2	22	FA610120	57.50
FTT/L	12	4.0 - 7.0	12.5/13.5	15	14.9	20	2	25	FA610122	99.60

HFT Fasteners AG

Bösch 37, CH-6331 Hünenberg
 Telefon +41-41 780 70 01 Fax +41-41 780 73 49
 Email: info@hft-fasteners.ch
 Internet: www.hft-fasteners.ch



ISO 9001 Nr. 96-241-041

FTT Inox

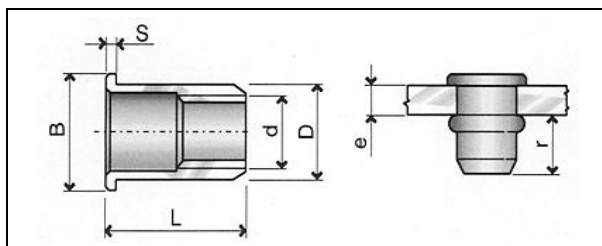

Blindnietmuttern Flachkopf

Insert fileté à tête cylindrique

Typ	M	e	r min/max	$\frac{\delta}{\sigma}$	D	B	S	L	Art.	Fr./100
FTT/C	3	0.3 - 1.0	5.5/5.8	5	4.9	7	0.8	8.5	FA611030	21.20
FTT/M	3	1.0 - 2.0	5.5/5.8	5	4.9	7	0.8	9.5	FA611031	21.20
FTT/L	3	2.0 - 3.0	5.5/5.8	5	4.9	7	0.8	10.5	FA611032	21.20
FTT/C	4	0.3 - 2.5	5.5/6.0	6	5.9	9	1	11	FA611040N	32.50
FTT/L	4	2.5 - 4.0	5.5/6.0	6	5.9	9	1	13	FA611042	32.50
FTT/C	5	0.5 - 3.0	7.2/7.7	7	6.9	10	1.2	13	FA611050N	47.70
FTT/L	5	3.0 - 5.0	7.2/7.7	7	6.9	10	1.2	15.5	FA611052	47.70
FTT/C	6	0.5 - 3.0	7.6/8.2	9	8.9	12	1.5	14.5	FA611060	63.90
FTT/L	6	3.0 - 5.5	7.6/8.2	9	8.9	12	1.5	17.5	FA611062	83.-
FTT/C	8	0.8 - 3.5	9.5/10.1	11	10.9	15	1.5	17.5	FA611080N	94.-
FTT/L	8	3.5 - 6.0	9.5/10.1	11	10.9	15	1.5	20	FA611082	135.50
FTT/C	10	1.0 - 3.5	13/14	13	12.9	17	1.7	21	FA611010	155.70
FTT/L	10	3.5 - 6.0	13/14	13	12.9	17	1.7	24	FA611012	177.70
FTT/C	12	1.0 - 4.0		16	15.9	23	2.0	23	FA611120	213.50

HFT Fasteners AG

Bösch 37, CH-6331 Hünenberg
 Telefon +41-41 780 70 01 Fax +41-41 780 73 49
 Email: info@hft-fasteners.ch
 Internet: www.hft-fasteners.ch



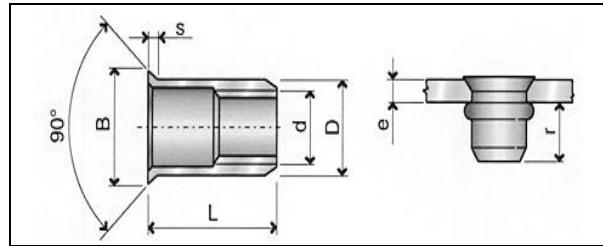

ISO 9001 Nr. 96-241-041

FTS Aluminium



Blindnietmutter Senkkopf

Insert fileté à tête fraisée

Typ	M		r min/max		D	B	S	L	Art.	Fr./100
FTS/C	3	1.5 - 2.8	4.7/5.3	5	4.9	8	1.5	9.5	FA640030	12.20
FTS/L	3	2.8 - 4.0	4.7/5.3	5	4.9	8	1.5	10.5	FA640032	12.20
FTS/C	4	1.5 - 3.5	5.3/6.1	6	5.9	9	1.5	11	FA640040	14.-
FTS/L	4	3.5 - 5.0	5.3/6.1	6	5.9	9	1.5	13	FA640042	14.-
FTS/C	5	1.5 - 3.8	6.8/7.3	7	6.9	10	1.5	13	FA640050	11.20
FTS/L	5	3.8 - 6.0	6.8/7.3	7	6.9	10	1.5	15	FA640052	14.50
FTS/C	6	1.5 - 3.8	8.5/9.2	9	8.9	12	1.5	15	FA640060	15.20
FTS/L	6	3.8 - 6.0	8.5/9.2	9	8.9	12	1.5	17	FA640062	19.-
FTS/C	8	1.5 - 3.8	9.5/10.4	11	10.9	14	1.5	16.5	FA640080	23.40
FTS/L	8	3.8 - 6.0	9.5/10.4	11	10.9	14	1.5	19	FA640081	28.50
FTS/C	10	1.5 - 4.5	11/12	12	11.9	15	1.5	18	FA640010	42.50
FTS/L	10	3.8 - 6.0	11/12	12	11.9	15	1.5	20.5	FA640102	42.50

HFT Fasteners AG

Bösch 37, CH-6331 Hünenberg
 Telefon +41-41 780 70 01 Fax +41-41 780 73 49
 Email: info@hft-fasteners.ch
 Internet: www.hft-fasteners.ch



ISO 9001 Nr. 96-241-041

FTS Stahl v. / acier z.

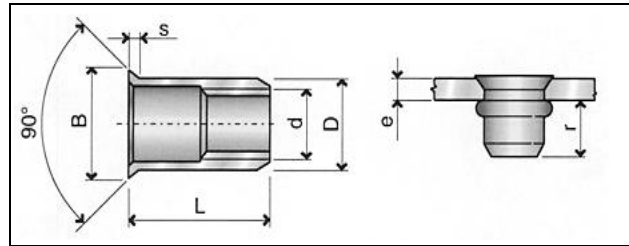

Blindnietmutter Senkkopf

Insert fileté à tête fraisée

Typ	M	e	r min/max	\emptyset	D	B	S	L	Art.	Fr./100
FTS/C	3	1.5 - 2.8	4.7/5.3	5	4.9	8	1.5	9.5	FA630030	12.40
FTS/L	3	2.8 - 4.0	4.7/5.3	5	4.9	8	1.5	10.5	FA630032	12.40
FTS/C	4	1.5 - 3.5	5.8/6.1	6	5.9	9	1.5	11	FA630040	12.90
FTS/L	4	3.5 - 5.0	5.8/6.1	6	5.9	9	1.5	13	FA630042	12.90
FTS/C	5	1.5 - 3.8	6.3/7.3	7	6.9	10	1.5	13	FA630050	10.60
FTS/L	5	3.8 - 6.0	6.3/7.3	7	6.9	10	1.5	15	FA630052	14.-
FTS/C	6	1.5 - 3.8	8.5/9.2	9	8.9	12	1.5	15	FA630060	13.40
FTS/L	6	3.8 - 6.0	8.5/9.2	9	8.9	12	1.5	17	FA630062	18.40
FTS/C	8	1.5 - 3.8	9.2/10.2	11	10.9	14	1.5	16.5	FA630080	16.20
FTS/L	8	3.8 - 6.0	9.2/10.2	11	10.9	14	1.5	19	FA630081	17.20
FTS/C	10	1.5 - 3.8	11/12	12	11.9	15	1.5	18	FA630100	20.80
FTS/L	10	3.8 - 6.0	11/12	12	11.9	15	1.5	20.5	FA630102	20.80

HFT Fasteners AG

Bösch 37, CH-6331 Hünenberg
 Telefon +41-41 780 70 01 Fax +41-41 780 73 49
 Email: info@hft-fasteners.ch
 Internet: www.hft-fasteners.ch



ISO 9001 Nr. 96-241-041

FTS Inox

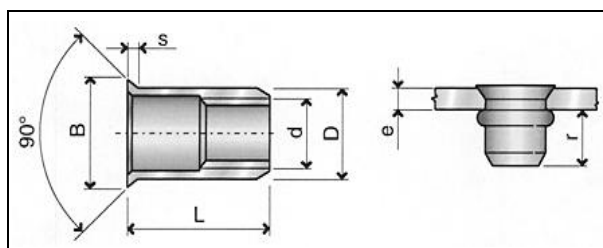

Blindnietmutter Senkkopf

Insert fileté à tête fraisée

Typ	M	e	r min/max	Ø	D	B	S	L	Art.	Fr./100
FTS/C	4	1.5 - 3.5	5.8/6.3	6	5.9	9	1.5	11	FA631040N	32.50
FTS/L	4	3.5 - 5.0	5.8/6.3	6	5.9	9	1.5	13	FA631042	32.50
FTS/C	5	1.5 - 3.8	6.8/7.3	7	6.9	10	1.5	13	FA631050N	37.10
FTS/L	5	3.8 - 6.0	6.8/7.3	7	6.9	10	1.5	15	FA631052	46.30
FTS/C	6	1.5 - 3.8	8.5/9.2	9	8.9	12	1.5	15	FA631060N	63.90
FTS/L	6	3.8 - 6.0	8.5/9.2	9	8.9	12	1.5	17	FA631062	83.-
FTS/C	8	1.5 - 3.8	9.5/10.4	11	10.9	14	1.5	16.5	FA631080N	94.-
FTS/L	8	3.8 - 6.0	9.5/10.4	11	10.9	14	1.5	19	FA631082	104.70
FTS/C	10	1.5 - 3.5	11.5/12.5	13	12.9	16	1.5	18	FA631100	155.70
FTS/L	10	3.5 - 6.0	11.5/12.5	13	12.9	16	1.5	20.5	FA631102	177.70

HFT Fasteners AG

Bösch 37, CH-6331 Hünenberg
 Telefon +41-41 780 70 01 Fax +41-41 780 73 49
 Email: info@hft-fasteners.ch
 Internet: www.hft-fasteners.ch



ISO 9001 Nr. 96-241-041

FTR Stahl v. / acier z.

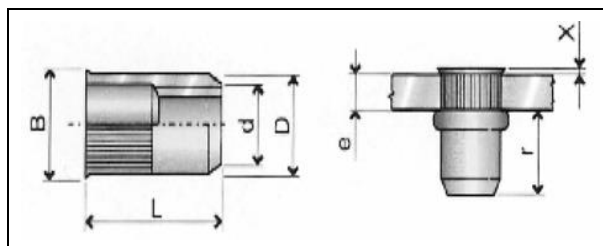

Blindnietmutter Kleinkopf, gerändelt

Insert fileté à tête fraisée, rainurée

Typ	M	e	r min/max	$\frac{\delta}{\delta}$	D	B	X	L	Art.	Fr./100
FTR/C *	3	0.5 - 1.5	5.4/5.8	5	4.9	5.5	0.3	8.5	FA650031	11.20
FTR/L *	3	1.5 - 2.5	5.4/5.8	5	4.9	5.5	0.3	9.5	FA650032	11.20
FTR/C	4	0.5 - 1.5	6.5/7.0	6	5.9	6.75	0.4	10	FA62204002	12.20
FTR/L	4	1.5 - 2.5	6.5/7.0	6	5.9	6.75	0.4	11	FA650042	12.20
FTR/C	5	0.5 - 2.0	7.5/8.0	7	6.9	8	0.4	12	FA62205002	10.10
FTR/L	5	2.0 - 3.5	7.5/8.0	7	6.9	8	0.4	13.5	FA650052	14.-
FTR/C	6	0.5 - 2.0	9.0-9.7	9	8.9	10	0.4	13.5	FA62206002	13.40
FTR/L	6	2.0 - 3.5	9.0-9.7	9	8.9	10	0.4	15	FA650062	18.40
FTR/C	8	1.0 - 2.5	10.7/11.4	11	10.9	12	0.4	16.5	FA62208002	16.20
FTR/L	8	2.5 - 4.0	10.7/11.4	11	10.9	12	0.4	18	FA650082	16.20
FTR/C *	10	1.0 - 2.5	12.3/13.1	12	11.9	13.5	0.4	18	FA650100	30.70
FTR/L *	10	2.5 - 4.0	12.3/13.1	12	11.9	13.5	0.4	19.5	FA650102	30.70

HFT Fasteners AG

Bösch 37, CH-6331 Hünenberg
 Telefon +41-41 780 70 01 Fax +41-41 780 73 49
 Email: info@hft-fasteners.ch
 Internet: www.hft-fasteners.ch



ISO 9001 Nr. 96-241-041

FTR Inox

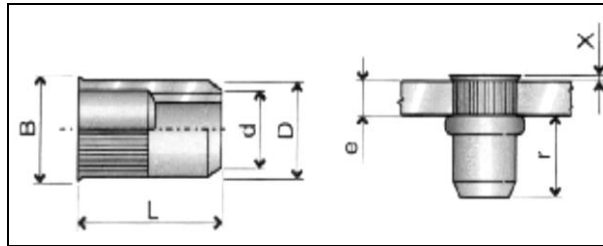

Blindnietmutter Kleinkopf, gerändelt

Insert fileté à tête fraisée, rainurée

Typ	M	e	r min/max	$\frac{\delta}{\delta_{max}}$	D	B	X	L	Art.	Fr./100
FTR	4	0.5 - 1.5	8.0	6	5.9	6.75	0.4	10	FA64504001	26.30
FTR	4	0.5 - 2.5	7.0	6	6.0	7	0.8	10	FA7550412000	23.-
FTR	5	0.5 - 3.0	8.0	7	7.0	8	0.8	11.5	FA05115FM2	25.80
FTR	6	0.5 - 3.0	10.0	9	9.0	10	0.8	14	FA06140FM2	34.60
FTR	8	0.5 - 3.0	12.0	11	11	12	0.8	15.5	FA08155FM2	48.20
FTR	10	0.8 - 3.5	14.5	13	13	14.5	0.8	19.5	FA641012000	53.30

HFT Fasteners AG

Bösch 37, CH-6331 Hünenberg
 Telefon +41-41 780 70 01 Fax +41-41 780 73 49
 Email: info@hft-fasteners.ch
 Internet: www.hft-fasteners.ch



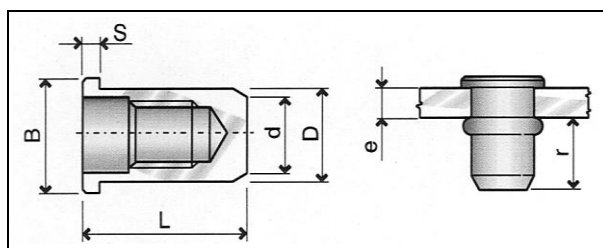

ISO 9001 Nr. 96-241-041

FTTC Aluminium



Blindnietmutter Flachkopf, Rundschaft, geschlossen

Insert fileté tête cylindrique, fermée

Typ	M		r min/max		D	B	S	L	Art.	Fr./100
FTTC/C	4	0.5 - 2.5	11.3/12	6	5.9	9	1	16.5	FA623040	24.-
FTTC/L	4	2.5 - 4.0	11.3/12	6	5.9	9	1	18	FA623042	24.-
FTTC/C	5	0.5 - 3.0	12.3/13	7	6.9	10	1.2	18	FA623050	28.50
FTTC/L	5	3.0 - 5.0	12.3/13	7	6.9	10	1.2	20.5	FA623052	28.50
FTTC/C	6	0.5 - 2.3	14/14.5	9	8.9	12	1.5	20.5	FA623060	26.30
FTTC/M	6	2.3 - 4.0	14/14.5	9	8.9	12	1.5	22	FA623061	35.90
FTTC/L	6	4.0 - 6.0	14/14.5	9	8.9	12	1.5	23.5	FA623062	33.10
FTTC/C	8	0.8 - 3.5	17.5/18.2	11	10.9	15	1.5	25.5	FA623080	44.10
FTTC/L	8	3.5 - 6.0	17.5/18.2	11	10.9	15	1.5	28	FA623082	44.10
FTTC/C	10	1.0 - 3.5	20.1/21.1	12	11.9	16	1.7	29	FA623010	56.-
FTTC/L	10	3.5 - 6.0	20.1/21.1	12	11.9	16	1.7	31.5	FA623012	60.40

HFT Fasteners AG

Bösch 37, CH-6331 Hünenberg
 Telefon +41-41 780 70 01 Fax +41-41 780 73 49
 Email: info@hft-fasteners.ch
 Internet: www.hft-fasteners.ch



ISO 9001 Nr. 96-241-041

FTTC Stahl v. / acier z.

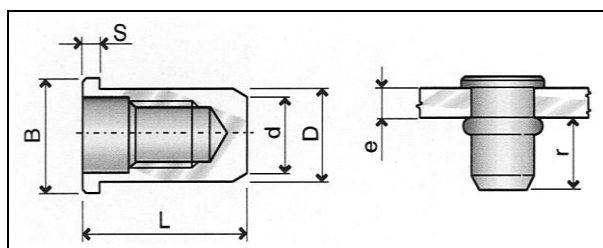

Blindnietmutter Flachkopf, Rundschaft, geschlossen

Insert fileté tête cylindrique, fermée

Typ	M	e	r min/max	Ø	D	B	S	L	Art.	Fr./100
FTTC/C	4	0.3 - 2.5	11.3/12	6	5.9	9	1	18	FA613040	20.90
FTTC/C	5	0.5 - 3.0	12.3/13	7	6.9	10	1.2	18	FA613050	28.50
FTTC/L	5	3.0 - 5.0	12.3/13	7	6.9	10	1.2	20.5	FA613052	28.50
FTTC/C	6	0.5 - 2.3	14/14.5	9	8.9	12	1.5	20.5	FA613060	30.70
(FTTC/M)	6	2.3 - 4.0	14/14.5	9	8.9	12	1.5	22	FA613061	30.70
FTTC/L	6	3.5 - 5.5	14/14.5	9	8.9	12	1.5	23.5	FA613062	34.60
FTTC/C	8	0.8 - 3.5	17.5/18.2	11	10.9	15	1.5	25.5	FA613080	40.80
FTTC/L	8	3.5 - 6.0	17.5/18.2	11	10.9	15	1.5	28	FA613082	40.80
FTTC/C	10	1.0 - 3.5	20.1/21.1	12	11.9	16	1.7	29	FA613010	49.20

HFT Fasteners AG

Bösch 37, CH-6331 Hünenberg
 Telefon +41-41 780 70 01 Fax +41-41 780 73 49
 Email: info@hft-fasteners.ch
 Internet: www.hft-fasteners.ch



ISO 9001 Nr. 96-241-041

FTT-Z Stahl v. / acier z.

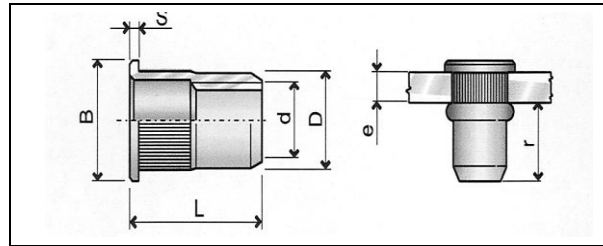

Auslaufotyp / fin de série

Ersatz / remplacé par
 FTT / Seite / page 35

Blindnietmutter Flachkopf, Rundschaft, gerändelt

Insert fileté tête cylindrique, cannelée

Typ	M	e	r min/max	$\frac{\phi}{S}$	D	B	S	L	Art.	Fr./100
FTT-Z/M	4	1.5 - 2.5	7/7.5	6	5.9	9	1	12	FA62104202	14.00
FTT-Z/L	4	2.5 - 3.5	7/7.5	6	5.9	9	1	13	FA62104302	14.00
FTT-Z/C	5	0.5 - 2.0	8/8.5	7	6.9	10	1.2	13	FA62105102	16.20
FTT-Z/L	5	3.5 - 5.0	8/8.5	7	6.9	10	1.2	16	FA62105302	16.20
FTT-Z/L	6	3.5 - 5.0	8/9	9	8.9	12	1.5	17.5	FA62106302	20.10
FTT-Z/L	8	4.0 - 5.5	10.2/11.2	11	10.9	15	1.5	20.5	FA62108302	31.30

HFT Fasteners AG

Bösch 37, CH-6331 Hünenberg
 Telefon +41-41 780 70 01 Fax +41-41 780 73 49
 Email: info@hft-fasteners.ch
 Internet: www.hft-fasteners.ch



ISO 9001 Nr. 96-241-041

FTTEC Stahl v. / acier z.

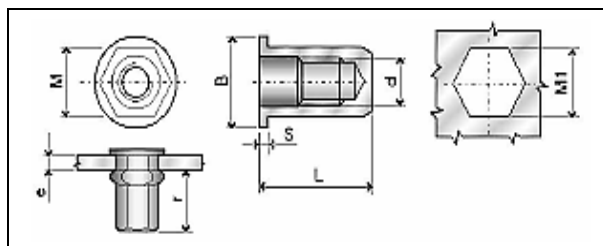

6-kant Nietmutter Flachkopf, geschlossen

Insert fileté 6-pan, cylindrique, fermé

Typ	M	e	r min/max	M1	M	B	S	L	Art.	Fr./100
FTTEC	6	0.5 - 3.0	15/16	9	8.9	13	1.5	22	FA63206001	31.40
FTTEC	8	0.5 - 3.0	18.8/19.5	11	10.9	16	1.5	26	FA631100012	32.50

FTRE Stahl v. / acier z.

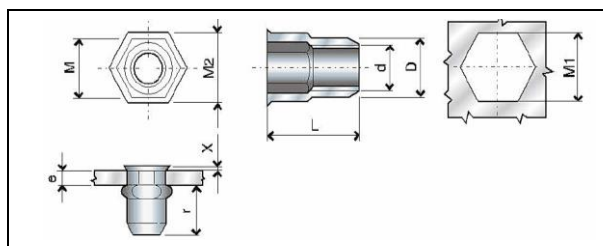

Teil 6-kant Nietmutter, Kleinkopf

Insert fileté 6-pan en partie, tête réduite

Typ	M	e	r min/max	M1	M	M2	X	D	L	Art.	Fr./100
FTRE	4	0.5 - 2.0	6.5/6.8	6.4	6.3	7.1	0.6	6.3	10.4	FA633040	14.50
FTRE	5	0.5 - 3.0	6.5/6.7	7.3	7.2	8	0.7	7.1	11.8	FA633050	15.60
FTRE	6	0.7 - 3.0	9.4/9.6	9.7	9.6	10.4	0.7	9.5	14.6	FA633060	19.70
FTRE	8	0.9 - 3.3	10.2/10.6	10.7	10.6	11.6	0.8	10.5	16	FA633080	23.-

HFT Fasteners AG

Bösch 37, CH-6331 Hünenberg
 Telefon +41-41 780 70 01 Fax +41-41 780 73 49
 Email: info@hft-fasteners.ch
 Internet: www.hft-fasteners.ch



ISO 9001 Nr. 96-241-041

IE Inox

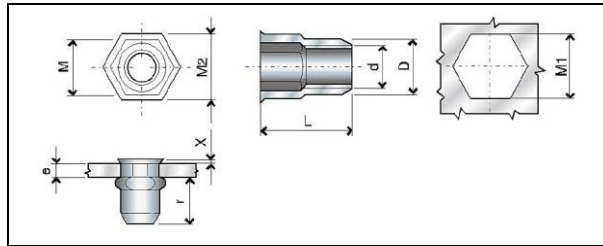

Teil 6-kant Nietmutter, Kleinkopf

Insert 6-pan en partie, tête réduite

Typ	M	e	r_{max}	M1	M	M2	X	D	L	Art.	Fr./100
IE	4	0.5 - 2.0	8	6	5.9	6.6	0.6	5.9	10.6	FA619040	40.50
IE	5	0.5 - 3.0	8	7	6.9	8	0.7	6.9	11.6	FA619050	50.15
IE	6	0.5 - 3.0	10.6	9	8.9	10	0.7	8.9	14.5	FA619060	71.20
IE	8	0.8 - 3.0	11.1	11	10.9	12	0.8	10.9	15.8	FA619080	107.60

IE Stahl

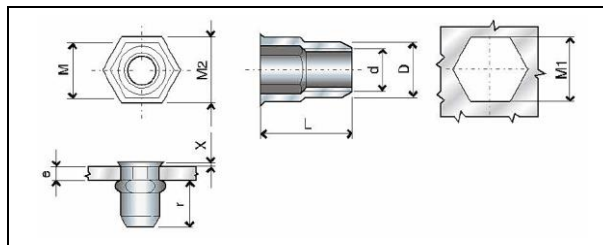

Teil 6-kant Nietmutter, Kleinkopf

Insert 6-pan en partie, tête réduite

Typ	M	e	r_{max}	M1	M	M2	X	D	L	Art.	Fr./100
IE	4	0.5 - 2.0	8	6	5.9	6.6	0.6	5.9	10.6	FA660040	11.20
IE	5	0.5 - 3.0	8	7	6.9	8	0.7	6.9	11.6	FA660050	11.40
IE	6	0.5 - 3.0	10.6	9	8.9	10	0.7	8.9	14.5	FA660060	15.40
IE	8	0.8 - 3.0	11	11	10.9	12	0.8	10.9	15.8	FA660080	18.90

IE weichen von dem Typ FTRE in der Sechskantabmessung ab.
 IE Ils diffèrent du modèle FTRE par la dimension de l'hexagone.

HFT Fasteners AG

Bösch 37, CH-6331 Hünenberg
Telefon +41-41 780 70 01 Fax +41-41 780 73 49
Email: info@hft-fasteners.ch
Internet: www.hft-fasteners.ch



ISO 9001 Nr. 96-241-041

*Die Preise auf den nachfolgenden Seiten sind **netto** + MWST.* *Les prix sur les pages suivantes sont **nets** + TVA*

Nasslackieren Nieten :	Thermolaque rivets
< 1'500 Stk. Fr. 250.- Fix	< 1'500 Stk. Fr. 250.- Fix
> 1'500 Stk. – 3'000 Stk. Fr .17.- / 100 Stk.	> 1'500 Stk. – 3'000 Stk. Fr .17.- / 100 pcs..
> 3'000 Stk. Fr. 15.- / .100 Stk.	> 3'000 Stk. Fr. 15.- / 100 pcs.
IGP oder lackieren nach Farbmuster + Fr. 95.- Farbmischzuschlag	IGP ou coloration selon échantillons de couleur + Fr. 95.- fix pour mélanger le couleur

HFT Fasteners AG

Bösch 37, CH-6331 Hünenberg
Telefon +41-41 780 70 01 Fax +41-41 780 73 49
Email: info@hft-fasteners.ch
Internet: www.hft-fasteners.ch



ISO 9001 Nr. 96-241-041

Hand-Nietwerkzeuge

Outils à river manuel

K 39

für Stahl- & Alu-Nieten
bis \varnothing 4,8 mm
Kopfhöhe 80 mm



0,5 kg

Fr. 37.50 netto
(W0700039)

K 39

pour rivets en acier et en
alu jusqu'à \varnothing 4,8 mm
hauteur nez de pose 80 mm

TT 55-D

Handnietzange für Stahl-
Nieten bis \varnothing 3,2 mm
& Alu bis \varnothing 4,0 mm
Kopfhöhe 75 mm



0,5 kg

Fr. 39.- netto
(WTT55F)

TT 55-D

Pince à river pour rivets en
acier jusqu'à \varnothing 3,2 mm
et en alu \varnothing 4,0 mm
hauteur nez de pose 75 mm

TT 55-D original POP

Handnietzange für Stahl-
Nieten bis \varnothing 3,2 mm
& Alu bis \varnothing 4,0 mm
Kopfhöhe 75 mm



0,5 kg

Fr. 50.- netto
(WMTT550)

TT 55-D original POP

Pince à river pour rivets en
acier jusqu'à \varnothing 3,2 mm
et en alu \varnothing 4,0 mm
hauteur nez de pose 75 mm

K 25

Hebelnietgerät für
Alu-Nieten bis \varnothing 7,8 mm &
Stahl-Nieten bis \varnothing 6,4 mm



1,5 kg

Fr. 85.50 netto
(W00K20)

K 25

Outil à river pour rivets alu
jusqu'à \varnothing 7,8 mm &
rivets acier jusqu'à \varnothing 6,4 mm

K 5 / 96

Expander-Nietgerät für
Alu-Nieten bis \varnothing 6,4 mm &
Stahl-Nieten \varnothing 4,8 mm



1,5 kg

Fr. 89.50 netto
(W010064P)

K 5 / 96

Riveteuse à expansion
pour rivets alu \varnothing 6,4 mm &
rivets acier jusqu'à \varnothing 4,8 mm

HFT Fasteners AG

Bösch 37, CH-6331 Hünenberg
Telefon +41-41 780 70 01 Fax +41-41 780 73 49
Email: info@hft-fasteners.ch
Internet: www.hft-fasteners.ch



ISO 9001 Nr. 96-241-041

Pneumatische Nietpistolen

Riveteuses pneumatiques

RAC 210

Hydraulisch-pneumatische
Nietpistole mit Dornfänger
für

Alu-Nieten bis $\varnothing = 4,8$ mm

Stahl & Inox bis $\varnothing = 4,0$ mm



6 kg

Fr. 462.- netto
(WRAC210)

RAC 210

Pistolet à river oléopneumatique
avec récupération de mandrins
pour

rivets alu jusqu'à $\varnothing = 4,8$ mm

acier & inox " $\varnothing = 4,0$ mm

RAC 182

Hydraulisch-pneumatische
Nietpistole mit Dornfänger
für

Alu-Nieten bis $\varnothing = 6,4$ mm

Stahl & Inox bis $\varnothing = 4,8$ mm

Magna-Lok bis $\varnothing = 4,8$ mm



1,6 kg

Fr. 534.- netto
(WRAC18)

RAC 182

Pistolet à river oléopneumatique
avec récupération de mandrins
pour

rivets alu jusqu'à $\varnothing = 6,4$ mm

acier & inox " $\varnothing = 4,8$ mm

Magna-Lok " $\varnothing = 4,8$ mm

RAC 171

Hydraulisch-pneumatische
Nietpistole mit Dornfänger
für

Alu-Nieten bis $\varnothing = 7,8$ mm

Stahl & Inox bis $\varnothing = 6,4$ mm

Magna-Lok bis $\varnothing = 4,8$ & 6,4



2.9 kg

Fr. 739.- netto
(WRAC171)

RAC 171

Pistolet à river oléopneumatique
avec récupération de mandrins
pour

rivets alu jusqu'à $\varnothing = 7,8$ mm

acier & inox " $\varnothing = 6,4$ mm

Magna-Lok " $\varnothing = 4,8$ & 6,4

HFT Fasteners AG

Bösch 37, CH-6331 Hünenberg
Telefon +41-41 780 70 01 Fax +41-41 780 73 49
Email: info@hft-fasteners.ch
Internet: www.hft-fasteners.ch



ISO 9001 Nr. 96-241-041

Akku-Nietgeräte

Riveteuses accu

Akku Nietgerät für alle Nieten
bis $\varnothing = 5$ mm

- * **Gerätehub: 20 mm**
- * **Setzkraft: 8'000 N**
- * ausgewogene Schwerpunktlage
handgerechter Griff
- * Auffangbehälter für abgerissene
Nietdorne
- * sofort-Rückstellung in
Ausgangsposition
- * Akku: 14,4 V / 2,0 Ah Li-Ion
- * mit Schnell-Ladegerät Li-Ion

Accu Bird
2 kg



Riveteuse accu pour rivets
jusqu'à $\varnothing = 5$ mm

- * **levée de l'outil: 20 mm**
- * **force de pose: 8'000 N**
- * l'appareil est bien équilibré
en main
- * avec récupération des
Mandarins
- * retour immédiat à la
position de départ
- * accu: 14,4 V / 2,0 Ah Li-Ion
- * avec chargeur rapide Li-Ion

Nieter+Lader+Stahlkoffer+1 Akku
komplett

Fr. **1015.-** net
(W1402500)

Riveteuse+chargeur+malette+1 accu
complet

zusätzlicher Akku 2,0 Ah

Fr. **170.-** net
(19.55088)

accu aditionel 2,0 Ah

zusätzlicher Schnell-Lader

Fr. **152.-** net
(W1402635)

chargeur rapide aditionel

Hochleistungs Akku-Nietgerät
für alle Nieten bis $\varnothing 6,4$ mm
(Alu bis $\varnothing 8$ mm)

- * der **grosse Bruder** des Accu Bird
- * **Gerätehub: 20 mm**
- * **Setzkraft: 13'000 N**
- * Akku: 14,4 V / 4,0 Ah Li-Ion
- * mit Schnell-Ladegerät Li-Ion

Power Bird



2,4 kg

Riveteuse accu à grande per-
formance, pour rivets jusqu'au
 $\varnothing 6,4$ mm (alu jusqu'à 8 mm)

- * le **grand frère** du Accu Bird
- * **levée de l'outjl: 20 mm**
- * **force de pose: 13'000 N**
- * accu: 14,4 V / 4,0 Ah Li-Ion
- * avec chargeur rapide Li-Ion

Nieter+Lader+Stahlkoffer+1 Akku
komplett

Fr. **1'221.-** net
(W1400136)

Riveteuse+chargeur+malette+1 accu
complet

zusätzlicher Akku 4,0 Ah

Fr. **243.-** net
(19.5509)

accu aditionel 4,0 Ah

HFT Fasteners AG

Bösch 37, CH-6331 Hünenberg
Telefon +41-41 780 70 01 Fax +41-41 780 73 49
Email: info@hft-fasteners.ch
Internet: www.hft-fasteners.ch



ISO 9001 Nr. 96-241-041

<p>Akku Nietgerät für ALLE Nieten Ø 2.4 bis 4.8 mm</p>	<p>M12</p>	<p>Riveteuse accu pour TOUS les rivets Ø 2,4 à 4,8 mm</p>
<p>* Gerätehub: 20.3 mm * Setzkraft: 9'000 N</p>		<p>* levée de l'outil: 20,3 mm * force de pose: 9'000 N</p>
<p>* liegt sehr gut in der Hand</p>	<p>2,1kg</p>	<p>* bien équilibré en main</p>
<p>* sofortige Rückstellung in Arbeitsposition</p>		<p>* retour immédiat à la position de départ</p>
<p>* mit Auffangbehälter für abgerissene Dorne</p>		<p>* avec récupération des Mandarins</p>
<p>* mit LED Beleuchtung des Arbeitsbereichs</p>		<p>* Avec illumination LED de l'espace de travail</p>
<p>* mit Akku-Ladezustand Anzeige</p>		<p>* avec indicateur d'état de charge</p>
<p>Preis Nietgerät komplett mit + Mundstücke Ø 2,4 - 4,8mm + Ladegerät + sehr starker Akku 4 Ah + Reserve Akku 2 Ah + Kunststoff Koffer</p>	<p>Fr. 674.- (W4933464405)</p>	<p>Prix riveteuse complète avec + nez de pose Ø 2,4 à 4,8 mm + chargeur + accu très fort 4 Ah + accu de réserve 2Ah + malette plastique</p>
<p>ein dritter Akku 4 Ah zusätzlich</p>	<p>Fr. 118.- (4932430065)</p>	<p>un troisième accu 4 Ah en plus</p>
<p>ein zusätzliches Ladegerät</p>	<p>Fr. 116.- (4932352000)</p>	<p>un chargeur en plus</p>

HFT Fasteners AG

Bösch 37, CH-6331 Hünenberg
Telefon +41-41 780 70 01 Fax +41-41 780 73 49
Email: info@hft-fasteners.ch
Internet: www.hft-fasteners.ch



ISO 9001 Nr. 96-241-041

Nietmuttern-Geräte

Outils pour inserts filetés

KJ 21

Für Nietmuttern
**Alu & Stahl M3 - M8 und
Inox von M3 - M6**
inkl. Zugbolzen
im Kunststoffkoffer.



1,3 kg

Fr. 149.- netto
(WKJ021)

KJ 21

Pour écrous aveugles
**alu & acier M3 à M8 et inox
M3 à M6**
avec tirants.
dans coffret plastique.

KJ 29 Extra

Für Nietmuttern in
**Alu, Stahl & Inox
von M3 - M10**
inkl. Zugbolzen.



2 kg

Fr. 263.- netto
(WKJ028)

KJ 29 Extra

Pour écrous aveugles
**alu, acier & inox
de M3 à M10**
avec tirants.

KJ 60

Pneumatisches Nietmuttern-
Werkzeug für
**Alu, Stahl & Inox
von M3 – M8**
inkl. Zugbolzen
im Kunststoffkoffer.



2,2 kg

Fr. 1'257.- netto
(WKJ060)

KJ 60

Outil pneumatique
pour écrous aveugles
**alu, acier & inox
de M3 à M8**
avec tirants
dans coffret plastique.

KJ 45/S

Pneumatisches Nietmuttern-
Werkzeug für
**Alu, Stahl & Inox
von M4 – M12**
inkl. Zugbolzen
im Kunststoffkoffer.



2,9 kg

Fr. 1'836.- netto
(WKJ045)

KJ 45/S

Outil pneumatique
pour écrous aveugles
**alu, acier & inox
de M4 à M12**
avec tirants
dans coffret plastique.

Q-Tool

Akku - Nietmuttern-
Werkzeug für
**Alu, Stahl & Inox
von M4 – M12**
inkl. Zugbolzen und 2 Akku
im Kunststoffkoffer.



2.1kg

Fr. 1'296.- netto
(W0503QN12XL)

Q-Tool

Outil accu pour écrous
aveugles
**alu, acier & inox
de M3 à M12**
avec tirants et 2 accu
dans coffret plastique.

HFT Fasteners AG

Bösch 37, CH-6331 Hünenberg
 Telefon +41-41 780 70 01 Fax +41-41 780 73 49
 Email: info@hft-fasteners.ch
 Internet: www.hft-fasteners.ch



ISO 9001 Nr. 96-241-041

Nieten-Bohrer

rechts schneidend, extra kurz

HSS DIN 1897

Mèches pour rivets

coupure à droite, extra court

einseitig		1 côté
Ø mm	Art.	Fr.
3,3	B2334813	0.75 >50 0.65
4,1	B2411350	1.-
4,9	B2491350	1.-
5,1	B2511350	1.10

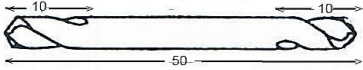
doppelseitig		2 côté
Ø mm	Art.	Fr.
3,3	B3331350	1.05 >50 0.80
4,1	B3411350	1.05
4,9	B3491350	1.50



Bohrer für in Inox

HSCO 5 UF-L 130°

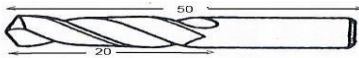
mèches pour inox

einseitig		1 côté
Ø mm	Art.	Fr.
3,3	B2334002	2.10
4,1	B218974D	2.85
4,9	B2189749	3.60

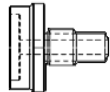
Mèches spéciales

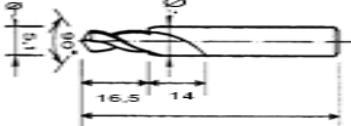
Dilatationsmundstück zu AccuBird für Alucobond Nietenkopf 16 mm Fr. 52.40 netto (1015549)		Buse dilatation pour AccuBird pour Alucobond tête rivet 16 mm Fr. 52.40 net (1015549)
Tiefenanschlag Fr. 30.- netto (18/8/18)		Butée de profondeur Fr. 30.- net (18/8/18)
Stufenbohrer-Pelicolor 5.1 x 8 mm oder 4,9 x 8 mm Fr. 47.70 netto (Z1061851)		Foret Pelicolor à étage 5.1 x 8 mm ou 4,9 x 8 mm Fr. 47.70 net (Z1061851)